

## Dual-Output Low Dropout Voltage Regulators with Power-Up Sequencing for Split-Voltage DSP Systems

Check for Samples: [TPS70145](#), [TPS70148](#), [TPS70151](#), [TPS70158](#), [TPS70102](#)

### FEATURES

- **Dual Output Voltages for Split-Supply Applications**
- **Selectable Power-Up Sequencing for DSP Applications**
- **Output Current Range of 500mA on Regulator 1 and 250mA on Regulator 2**
- **Fast Transient Response**
- **Voltage Options: 3.3V/2.5V, 3.3V/1.8V, 3.3V/1.5V, 3.3V/1.2V, and Dual Adjustable Outputs**
- **Open Drain Power-On Reset with 120ms Delay**
- **Open Drain Power Good for Regulator 1**
- **Ultra Low 190 $\mu$ A (typ) Quiescent Current**
- **1 $\mu$ A Input Current During Standby**
- **Low Noise: 65 $\mu$ V<sub>RMS</sub> Without Bypass Capacitor**
- **Quick Output Capacitor Discharge Feature**
- **Two Manual Reset Inputs**
- **2% Accuracy Over Load and Temperature**
- **Undervoltage Lockout (UVLO) Feature**
- **20-Pin PowerPAD™ TSSOP Package**
- **Thermal Shutdown Protection**

### DESCRIPTION

TPS701xx family devices are designed to provide a complete power management solution for the TMS320™ DSP family, processor power, ASIC, FPGA, and digital applications where dual output voltage regulators are required. Easy programmability of the sequencing function makes the TPS701xx family ideal for any TMS320 DSP applications with power sequencing requirements. Differentiated features, such as accuracy, fast transient response, SVS supervisory circuit, manual reset inputs, and an enable function, provide a complete system solution.

The TPS701xx family of voltage regulators offer very low dropout voltage and dual outputs with power-up sequence control, which is designed primarily for DSP applications. These devices have extremely low noise output performance without using any added filter bypass capacitors and are designed to have a fast transient response and be stable with 10 $\mu$ F low ESR capacitors.

These devices have fixed 3.3V/2.5V, 3.3V/1.8V, 3.3V/1.5V, 3.3V/1.2V, and adjustable/adjustable voltage options. Regulator 1 can support up to 500mA, and regulator 2 can support up to 250mA. Separate voltage inputs allow the designer to configure the source power.

**PWP PACKAGE  
(TOP VIEW)**

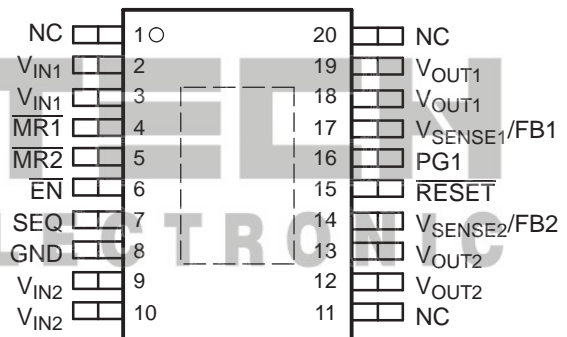

Please be aware that an important notice concerning availability, standard warranty, and use in critical applications of Texas Instruments semiconductor products and disclaimers thereto appears at the end of this data sheet.

PowerPAD, TMS320 are trademarks of Texas Instruments.  
All other trademarks are the property of their respective owners.

PRODUCTION DATA information is current as of publication date.  
Products conform to specifications per the terms of the Texas Instruments standard warranty. Production processing does not necessarily include testing of all parameters.

Copyright © 1999–2010, Texas Instruments Incorporated

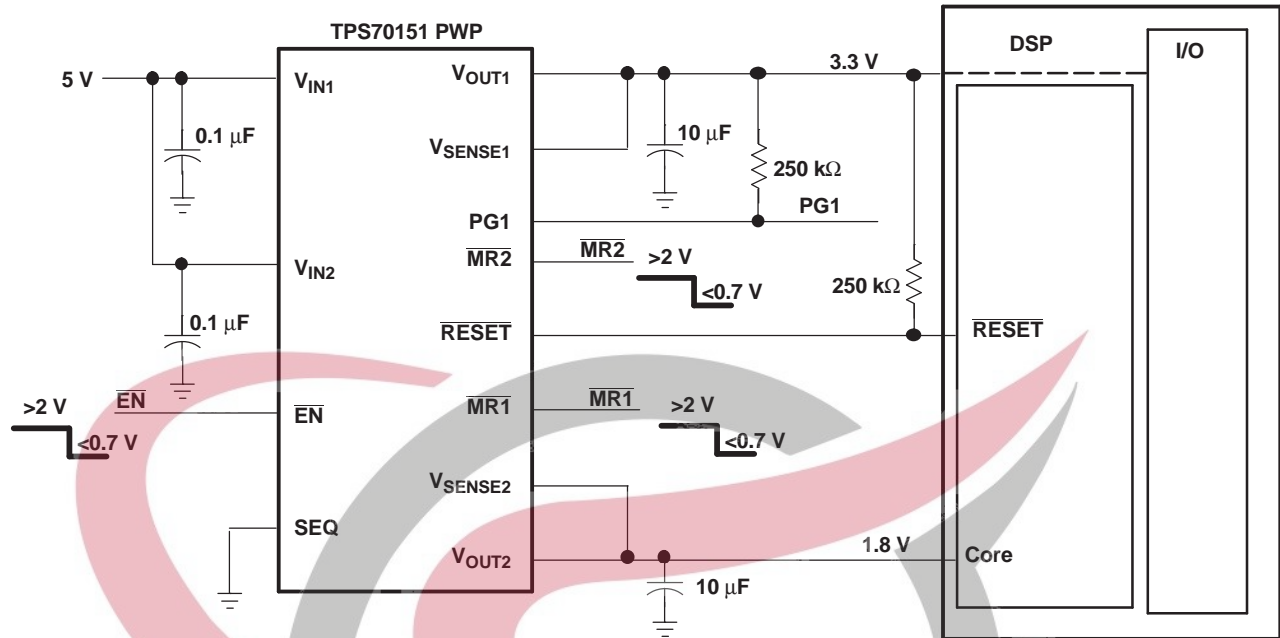

Because the PMOS device behaves as a low-value resistor, the dropout voltage is very low (typically 170mV on regulator 1) and is directly proportional to the output current. Additionally, since the PMOS pass element is a voltage-driven device, the quiescent current is very low and independent of output loading (maximum of 230µA over the full range of output current). This LDO family also features a sleep mode; applying a high signal to  $\overline{EN}$  (enable) shuts down both regulators, reducing the input current to 1µA at  $T_J = +25^\circ\text{C}$ .

The device is enabled when the  $\overline{EN}$  pin is connected to a low-level input voltage. The output voltages of the two regulators are sensed at the  $V_{SENSE1}$  and  $V_{SENSE2}$  pins, respectively.

The input signal at the SEQ pin controls the power-up sequence of the two regulators. When the device is enabled and the SEQ terminal is pulled high or left open,  $V_{OUT2}$  turns on first and  $V_{OUT1}$  remains off until  $V_{OUT2}$  reaches approximately 83% of its regulated output voltage. At that time  $V_{OUT1}$  is turned on. If  $V_{OUT2}$  is pulled below 83% (for example, an overload condition),  $V_{OUT1}$  is turned off. Pulling the SEQ terminal low reverses the power-up order and  $V_{OUT1}$  is turned on first. The SEQ pin is connected to an internal pull-up current source.

For each regulator, there is an internal discharge transistor to discharge the output capacitor when the regulator is turned off (disabled).

The PG1 pin reports the voltage conditions at  $V_{OUT1}$ , which can be used to implement an SVS for the circuitry supplied by regulator 1.

The TPS701xx features a  $\overline{RESET}$  (SVS, POR, or Power-On Reset).  $\overline{RESET}$  output initiates a reset in DSP systems and related digital applications in the event of an undervoltage condition.  $\overline{RESET}$  indicates the status of  $V_{OUT2}$  and both manual reset pins (MR1 and MR2). When  $V_{OUT2}$  reaches 95% of its regulated voltage and MR1 and MR2 are in the logic high state,  $\overline{RESET}$  goes to a high impedance state after a 120ms delay.  $\overline{RESET}$  goes to the logic low state when the  $V_{OUT2}$  regulated output voltage is pulled below 95% (for example, an overload condition) of its regulated voltage. To monitor  $V_{OUT1}$ , the PG1 output pin can be connected to MR1 or MR2.

The device has an undervoltage lockout (UVLO) circuit that prevents the internal regulators from turning on until  $V_{IN1}$  reaches 2.5V.



This integrated circuit can be damaged by ESD. Texas Instruments recommends that all integrated circuits be handled with appropriate precautions. Failure to observe proper handling and installation procedures can cause damage.

ESD damage can range from subtle performance degradation to complete device failure. Precision integrated circuits may be more susceptible to damage because very small parametric changes could cause the device not to meet its published specifications.

### ORDERING INFORMATION<sup>(1)</sup>

PRODUCT	VOLTAGE (V) <sup>(2)</sup>		PACKAGE-LEAD (DESIGNATOR)	SPECIFIED TEMPERATURE RANGE (T <sub>J</sub> )	ORDERING NUMBER	TRANSPORT MEDIA, QUANTITY
	V <sub>OUT1</sub>	V <sub>OUT2</sub>				
TPS70102	Adjustable	Adjustable	HTSSOP-20 (PWP)	-40°C to +125°C	TPS70102PWP	Tube, 70
					TPS70102PWPR	Tape and Reel, 2000
TPS70145	3.3 V	1.2 V	HTSSOP-20 (PWP)	-40°C to +125°C	TPS70145PWP	Tube, 70
					TPS70145PWPR	Tape and Reel, 2000
TPS70148	3.3 V	1.5 V	HTSSOP-20 (PWP)	-40°C to +125°C	TPS70148PWP	Tube, 70
					TPS70148PWPR	Tape and Reel, 2000
TPS70151	3.3 V	1.8 V	HTSSOP-20 (PWP)	-40°C to +125°C	TPS70151PWP	Tube, 70
					TPS70151PWPR	Tape and Reel, 2000
TPS70158	3.3 V	2.5 V	HTSSOP-20 (PWP)	-40°C to +125°C	TPS70158PWP	Tube, 70
					TPS70158PWPR	Tape and Reel, 2000

(1) For the most current package and ordering information see the Package Option Addendum located at the end of this document, or see the TI web site at [www.ti.com](http://www.ti.com).

(2) For fixed 1.20V operation, tie FB to OUT.

### ABSOLUTE MAXIMUM RATINGS<sup>(1)</sup>

Over operating free-air temperature range (unless otherwise noted).

	TPS701xx	UNIT
Input voltage range: V <sub>IN1</sub> , V <sub>IN2</sub> <sup>(2)</sup>	-0.3 to +7	V
Voltage range at EN	-0.3 to +7	V
Output voltage range (V <sub>OUT1</sub> , V <sub>SENSE1</sub> )	5.5	V
Output voltage range (V <sub>OUT2</sub> , V <sub>SENSE2</sub> )	5.5	V
Maximum $\overline{\text{RESET}}$ , PG1 voltage	7	V
Maximum MR1, MR2, and SEQ voltage	V <sub>IN1</sub>	V
Peak output current	Internally limited	—
Continuous total power dissipation	See Thermal Information Table	—
Junction temperature range, T <sub>J</sub>	-40 to +150	°C
Storage temperature range, T <sub>stg</sub>	-65 to +150	°C
ESD rating, HBM	2	kV

(1) Stresses beyond those listed under absolute maximum ratings may cause permanent damage to the device. These are stress ratings only, and functional operation of the device at these or any other conditions beyond those indicated under recommended operating conditions is not implied. Exposure to absolute-maximum-rated conditions for extended periods may affect device reliability.

(2) All voltages are tied to network ground.

## THERMAL INFORMATION

THERMAL METRIC <sup>(1) (2)</sup>		TPS701xx	UNITS
		PWP (20 PINS)	
$\theta_{JA}$	Junction-to-ambient thermal resistance	74.1	°C/W
$\theta_{JCTop}$	Junction-to-case (top) thermal resistance	43.1	
$\theta_{JB}$	Junction-to-board thermal resistance	19.7	
$\psi_{JT}$	Junction-to-top characterization parameter	2.9	
$\psi_{JB}$	Junction-to-board characterization parameter	17.3	
$\theta_{JCbott}$	Junction-to-case (bottom) thermal resistance	1.4	

(1) For more information about traditional and new thermal metrics, see the *IC Package Thermal Metrics* application report, [SPRA953](#).

(2) For thermal estimates of this device based on PCB copper area, see the [TI PCB Thermal Calculator](#).

## RECOMMENDED OPERATING CONDITIONS

Over operating temperature range (unless otherwise noted)

	MIN	MAX	UNIT
Input voltage, $V_I$ <sup>(1)</sup> (regulator 1 and 2)	2.7	6	V
Output current, $I_O$ (regulator 1)	0	500	mA
Output current, $I_O$ (regulator 2)	0	250	mA
Output voltage range (for adjustable option)	1.22	5.5	V
Operating junction temperature, $T_J$	-40	+125	°C

(1) To calculate the minimum input voltage for maximum output current, use the following equation:  $V_{I(min)} = V_{O(max)} + V_{DO(max\ load)}$ .

## ELECTRICAL CHARACTERISTICS

Over recommended operating junction temperature range ( $T_J = -40^\circ\text{C}$  to  $+125^\circ\text{C}$ ),  $V_{IN1}$  or  $V_{IN2} = V_{OUT(nom)} + 1\text{V}$ ,  $I_O = 1\text{mA}$ ,  $\overline{\text{EN}} = 0\text{V}$ ,  $C_O = 33\mu\text{F}$ , (unless otherwise noted).

PARAMETER		TEST CONDITIONS		MIN	TYP	MAX	UNIT
$V_O$	Reference voltage	$2.7\text{V} < V_I < 6\text{V}$ , $T_J = +25^\circ\text{C}$	FB connected to $V_O$		1.22		V
		$2.7\text{V} < V_I < 6\text{V}$ ,	FB connected to $V_O$	1.196		1.244	
	1.2V Output	$2.7\text{V} < V_I < 6\text{V}$ ,	$T_J = +25^\circ\text{C}$		1.2		
		$2.7\text{V} < V_I < 6\text{V}$ ,		1.176		1.224	
	1.5V Output	$2.7\text{V} < V_I < 6\text{V}$ ,	$T_J = +25^\circ\text{C}$		1.5		
		$2.7\text{V} < V_I < 6\text{V}$ ,		1.47		1.53	
	1.8V Output	$2.7\text{V} < V_I < 6\text{V}$ ,	$T_J = +25^\circ\text{C}$		1.8		
		$2.7\text{V} < V_I < 6\text{V}$ ,		1.764		1.836	
	2.5V Output	$2.7\text{V} < V_I < 6\text{V}$ ,	$T_J = +25^\circ\text{C}$		2.5		
		$2.7\text{V} < V_I < 6\text{V}$ ,		2.45		2.55	
3.3V Output	$2.7\text{V} < V_I < 6\text{V}$ ,	$T_J = +25^\circ\text{C}$		3.3			
	$2.7\text{V} < V_I < 6\text{V}$ ,		3.234		3.366		
Quiescent current (GND current) for regulator 1 and regulator 2, $\overline{\text{EN}} = 0\text{V}$ <sup>(1)</sup>		<sup>(2)</sup>	$T_J = +25^\circ\text{C}$		190		$\mu\text{A}$
		<sup>(2)</sup>				230	
Output voltage line regulation ( $\Delta V_O/V_O$ ) for regulator 1 and regulator 2 <sup>(3)</sup>		$V_O + 1\text{V} < V_I \leq 6\text{V}$ ,	$T_J = +25^\circ\text{C}$ <sup>(1)</sup>		0.01%		V
		$V_O + 1\text{V} < V_I \leq 6\text{V}$	<sup>(1)</sup>			0.1%	
Load regulation for $V_{OUT1}$ and $V_{OUT2}$		$T_J = +25^\circ\text{C}$	<sup>(2)</sup>		1		mV

(1) Minimum input operating voltage is 2.7V or  $V_{O(typ)} + 1\text{V}$ , whichever is greater. Maximum input voltage = 6V, minimum output current = 1mA.

(2)  $I_O = 1\text{mA}$  to 250mA for Regulator 1 and 1mA to 125mA for Regulator 2.

(3) If  $V_O < 1.8\text{V}$  then  $V_{I\max} = 6\text{V}$ ,  $V_{I\min} = 2.7\text{V}$ : 
$$\text{Line Reg. (mV)} = (\% / \text{V}) \times V_O \frac{(V_{I\max} - 2.7\text{V})}{100} \times 1000$$

If  $V_O > 2.5\text{V}$  then  $V_{I\max} = 6\text{V}$ ,  $V_{I\min} = V_O + 1\text{V}$ : 
$$\text{Line Reg. (mV)} = (\% / \text{V}) \times V_O \frac{(V_{I\max} - (V_O + 1\text{V}))}{100} \times 1000$$

**ELECTRICAL CHARACTERISTICS (continued)**

Over recommended operating junction temperature range ( $T_J = -40^\circ\text{C}$  to  $+125^\circ\text{C}$ ),  $V_{IN1}$  or  $V_{IN2} = V_{OUT(nom)} + 1\text{V}$ ,  $I_O = 1\text{mA}$ ,  $\overline{\text{EN}} = 0\text{V}$ ,  $C_O = 33\mu\text{F}$ , (unless otherwise noted).

PARAMETER		TEST CONDITIONS		MIN	TYP	MAX	UNIT
$V_n$	Output noise voltage	Regulator 1	BW 300Hz to 50kHz, $C_O = 33\mu\text{F}$ , $T_J = +25^\circ\text{C}$	65			$\mu\text{V}_{\text{RMS}}$
		Regulator 2		65			
Output current limit		Regulator 1	$V_{\text{OUT}} = 0\text{V}$	1.6	1.9		A
		Regulator 2		0.750	1		
Thermal shutdown junction temperature				+150			$^\circ\text{C}$
$I_I$ (standby)	Standby current	Regulator 1	$T_J = +25^\circ\text{C}$	$\overline{\text{EN}} = V_I$	1		$\mu\text{A}$
				$\overline{\text{EN}} = V_I$	3		
		Regulator 2		$\overline{\text{EN}} = V_I$	1		$\mu\text{A}$
				$\overline{\text{EN}} = V_I$	3		
PSRR	Power-supply ripple rejection	$f = 1\text{kHz}$ , $C_O = 33\mu\text{F}$ , $T_J = +25^\circ\text{C}^{(1)}$	60			dB	
<b>RESET Terminal</b>							
Minimum input voltage for valid $\overline{\text{RESET}}$		$I_{\text{RESET}} = 300\mu\text{A}$ , $V_{(\text{RESET})} \leq 0.8\text{V}$	1.0		1.3		V
Trip threshold voltage		$V_O$ decreasing	92%	95%	98%		$V_{\text{OUT}}$
Hysteresis voltage		Measured at $V_O$	0.5%				$V_{\text{OUT}}$
$t_{(\text{RESET})}$		RESET pulse duration	80	120	160		ms
$t_r(\text{RESET})$		Rising edge deglitch	30				$\mu\text{s}$
Output low voltage		$V_I = 3.5\text{V}$ , $I_{O(\text{RESET})} = 1\text{mA}$	0.15		0.4		V
Leakage current		$V_{(\text{RESET})} = 6\text{V}$			1		$\mu\text{A}$
<b>PG1 Terminal</b>							
Minimum input voltage for valid PG1		$I_{(\text{PG1})} = 300\mu\text{A}$ , $V_{(\text{PG1})} \leq 0.8\text{V}$	1.0		1.3		V
Trip threshold voltage		$V_O$ decreasing	92%	95%	98%		$V_{\text{OUT}}$
Hysteresis voltage		Measured at $V_O$	0.5%				$V_{\text{OUT}}$
$t_r(\text{PG1})$		Rising edge deglitch	30				$\mu\text{s}$
Output low voltage		$V_I = 2.7\text{V}$ , $I_{O(\text{PG1})} = 1\text{mA}$	0.15		0.4		V
Leakage current		$V_{(\text{PG1})} = 6\text{V}$			1		$\mu\text{A}$
<b>EN Terminal</b>							
High level $\overline{\text{EN}}$ input voltage			2				V
Low level $\overline{\text{EN}}$ input voltage					0.7		V
Input current ( $\overline{\text{EN}}$ )			-1	1			$\mu\text{A}$
Falling edge deglitch		Measured at $V_O$	140				$\mu\text{s}$
<b>SEQ Terminal</b>							
High level SEQ input voltage			2				V
Low level SEQ input voltage					0.7		V
SEQ pull-up current source			6				$\mu\text{A}$
<b>MR1 / MR2 Terminals</b>							
High level input voltage			2				V
Low level input voltage					0.7		V
Pull-up current source			6				$\mu\text{A}$
<b><math>V_{\text{OUT2}}</math> Terminal</b>							
$V_{\text{OUT2}}$ UV comparator: Positive-going input threshold voltage of $V_{\text{OUT2}}$ UV comparator			80% $V_O$	83% $V_O$	86% $V_O$		V
$V_{\text{OUT2}}$ UV comparator: Hysteresis			0.5% $V_O$				mV
$V_{\text{OUT2}}$ UV comparator: Falling edge deglitch		$V_{\text{SENSE}_2}$ decreasing below threshold	140				$\mu\text{s}$
Peak output current		2ms pulse width	375				mA

## ELECTRICAL CHARACTERISTICS (continued)

Over recommended operating junction temperature range ( $T_J = -40^\circ\text{C}$  to  $+125^\circ\text{C}$ ),  $V_{IN1}$  or  $V_{IN2} = V_{OUT(nom)} + 1\text{V}$ ,  $I_O = 1\text{mA}$ ,  $\overline{\text{EN}} = 0\text{V}$ ,  $C_O = 33\mu\text{F}$ , (unless otherwise noted).

PARAMETER	TEST CONDITIONS	MIN	TYP	MAX	UNIT
Discharge transistor current	$V_{OUT2} = 1.5\text{V}$		7.5		mA
<b><math>V_{OUT1}</math> Terminal</b>					
$V_{OUT1}$ UV comparator: Positive-going input threshold voltage of $V_{OUT1}$ UV comparator		80% $V_O$	83% $V_O$	86% $V_O$	V
$V_{OUT1}$ UV comparator: Hysteresis			0.5% $V_O$		mV
$V_{OUT1}$ UV comparator: Falling edge deglitch	$V_{SENSE\_1}$ decreasing below threshold		140		$\mu\text{s}$
<b><math>V_{OUT1}</math> Terminal, continued</b>					
Dropout voltage <sup>(4)</sup>	$I_O = 500\text{mA}$ , $T_J = +25^\circ\text{C}$ $V_{IN1} = 3.2\text{V}$		170		mV
Dropout voltage <sup>(4)</sup>	$I_O = 500\text{mA}$ , $V_{IN1} = 3.2\text{V}$			275	mV
Peak output current <sup>(4)</sup>	2ms pulse width		750		mA
Discharge transistor current	$V_{OUT1} = 1.5\text{V}$		7.5		mA
$V_{IN1}$ UVLO threshold		2.4		2.65	V
<b>FB Terminal</b>					
Input current: TPS70102	FB = 1.8V		1		$\mu\text{A}$

(4) Input voltage ( $V_{IN1}$  or  $V_{IN2}$ ) =  $V_{O(typ)} - 100\text{mV}$ . For 1.5V, 1.8V and 2.5V regulators, the dropout voltage is limited by input voltage range. The 3.3V regulator input is set to 3.2V to perform this test.

**SKYTECH**  
ELECTRONIC

DEVICE INFORMATION

Fixed Voltage Version

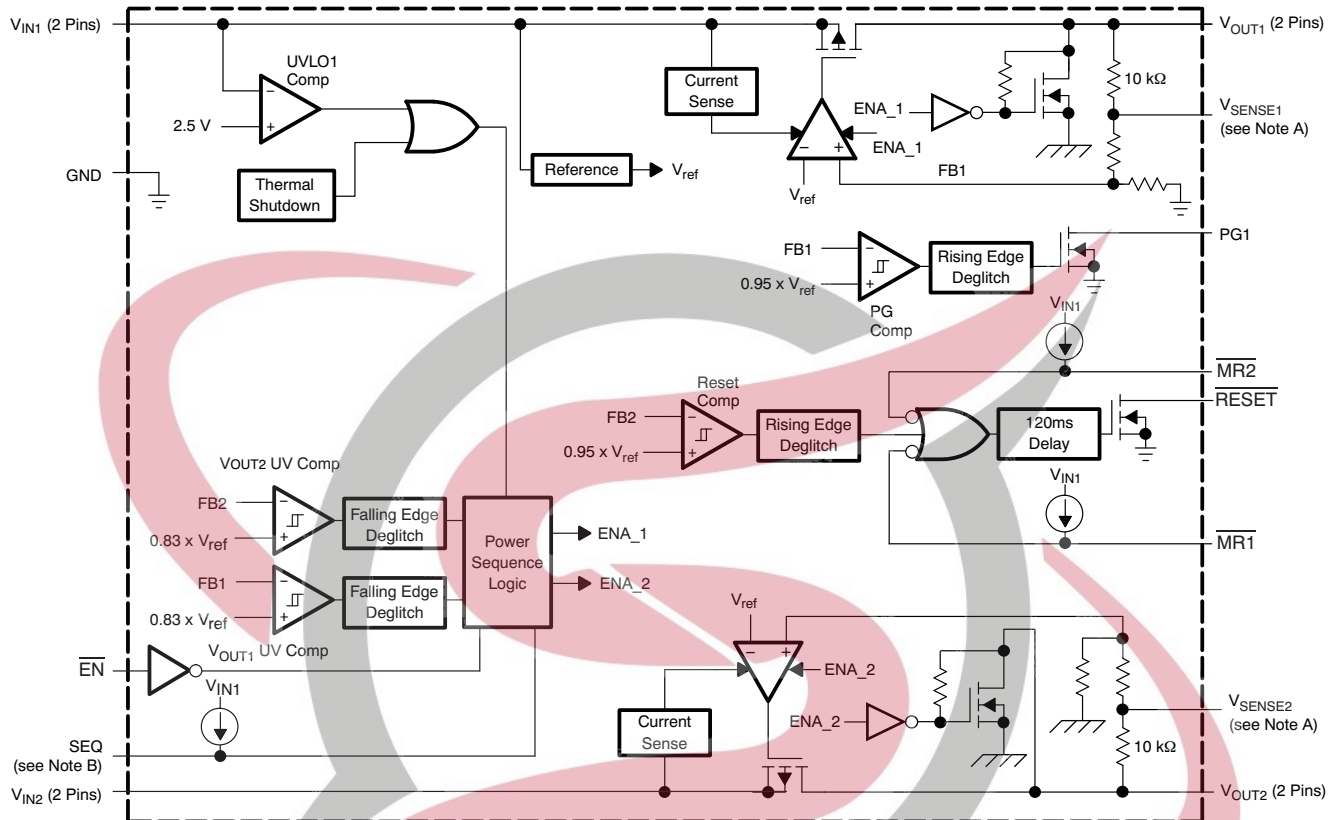

- A. For most applications,  $V_{SENSE1}$  and  $V_{SENSE2}$  should be externally connected to  $V_{OUT}$  as close as possible to the device. For other implementations, refer to SENSE terminal connection discussion in the [Application Information](#) section.
- B. If the SEQ terminal is floating at the input,  $V_{OUT2}$  powers up first.



Adjustable Voltage Version

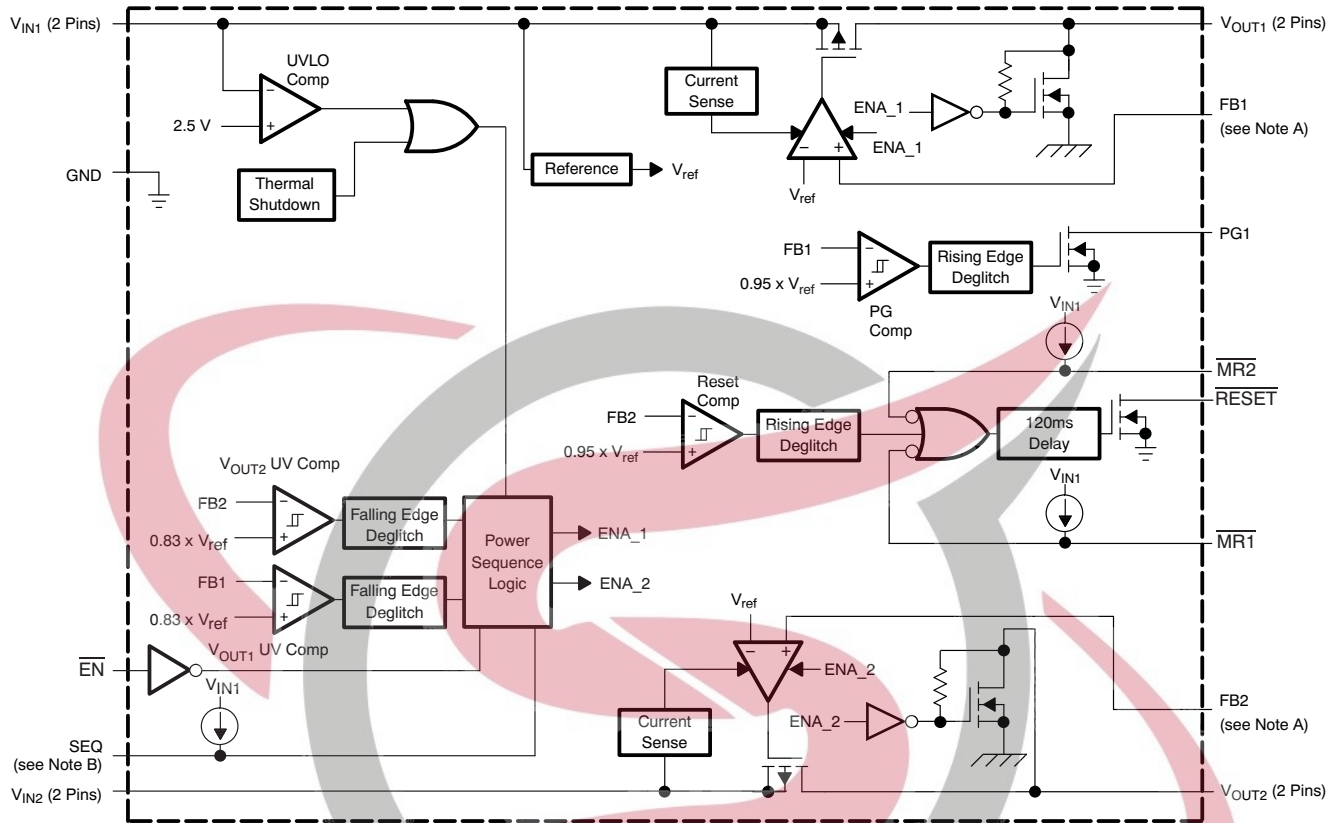

- A. For most applications, FB1 and FB2 should be externally connected to resistor dividers as close as possible to the device. For other implementations, refer to FB terminals connection discussion in the [Application Information](#) section.
- B. If the SEQ terminal is floating at the input, V<sub>OUT2</sub> powers up first





**RESET Timing Diagram (with  $V_{IN1}$  Powered Up)**

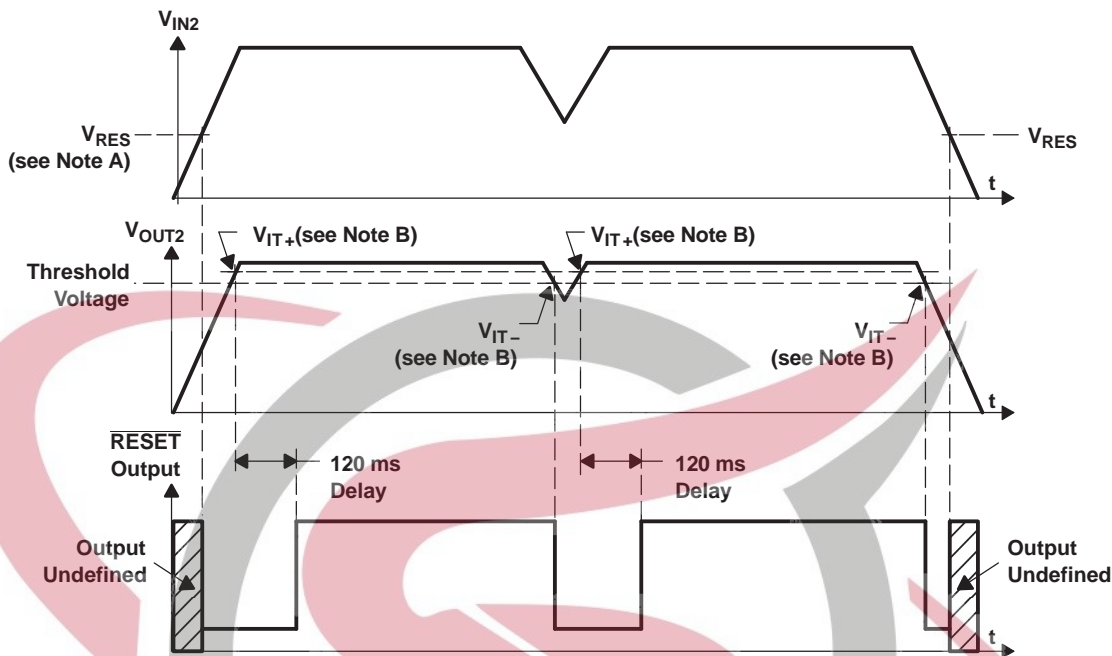

- NOTES: A.  $V_{RES}$  is the minimum input voltage for a valid RESET. The symbol  $V_{RES}$  is not currently listed within EIA or JEDEC standards for semiconductor symbology.  
B.  $V_{IT-}$  Trip voltage is typically 5% lower than the output voltage ( $95\%V_O$ )  $V_{IT-}$  to  $V_{IT+}$  is the hysteresis voltage.

**PG1 Timing Diagram**

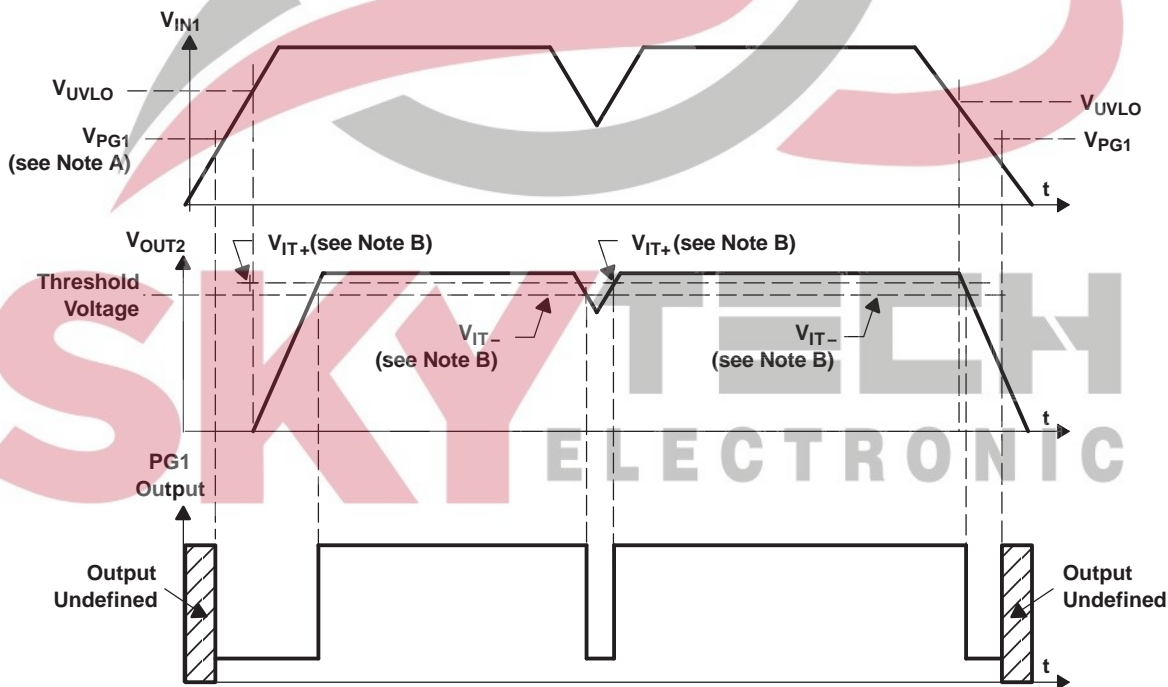

- NOTES: A.  $V_{PG1}$  is the minimum input voltage for a valid PG1. The symbol  $V_{PG1}$  is not currently listed within EIA or JEDEC standards for semiconductor symbology.  
B.  $V_{IT-}$  Trip voltage is typically 5% lower than the output voltage ( $95\%V_O$ )  $V_{IT-}$  to  $V_{IT+}$  is the hysteresis voltage.

**Table 1. TERMINAL FUNCTIONS**

TERMINAL		I/O	DESCRIPTION
NAME	NO.		
$\overline{\text{EN}}$	6	I	Active low enable
GND	8	—	Ground
$\overline{\text{MR1}}$	4	I	Manual reset input 1, active low, pulled up internally
$\overline{\text{MR2}}$	5	I	Manual reset input 2, active low, pulled up internally
NC	1, 11, 20	—	No connection
PG1	16	O	Open drain output, low when $V_{\text{OUT1}}$ voltage is less than 95% of the nominal regulated voltage
$\overline{\text{RESET}}$	15	O	Open drain output, SVS (power-on reset) signal, active low
SEQ	7	I	Power-up sequence control: SEQ = High, $V_{\text{OUT2}}$ powers up first; SEQ = Low, $V_{\text{OUT1}}$ powers up first, SEQ terminal pulled up internally.
$V_{\text{IN1}}$	2, 3	I	Input voltage of regulator 1
$V_{\text{IN2}}$	9, 10	I	Input voltage of regulator 2
$V_{\text{OUT1}}$	18, 19	O	Output voltage of regulator 1
$V_{\text{OUT2}}$	12, 13	O	Output voltage of regulator 2
$V_{\text{SENSE2}}/\text{FB2}$	14	I	Regulator 2 output voltage sense/regulator 2 feedback for adjustable
$V_{\text{SENSE1}}/\text{FB1}$	17	I	Regulator 1 output voltage sense/regulator 1 feedback for adjustable

## Detailed Description

The TPS701xx low dropout regulator family provides dual regulated output voltages for DSP applications that require high-performance power management solutions. These devices provide fast transient response and high accuracy with small output capacitors, while drawing low quiescent current. Programmable sequencing provides a power solution for DSPs without any external component requirements. This architecture reduces the component cost and board space while increasing total system reliability. The TPS701xx family has an enable feature that puts the device in sleep mode reducing the input currents to less than 3 $\mu$ A. Other features are integrated SVS (Power-On Reset,  $\overline{\text{RESET}}$ ) and Power Good (PG1) that monitor output voltages and provide logic output to the system. These differentiated features provide a complete DSP power solution.

The TPS701xx, unlike many other LDOs, feature very low quiescent current that remains virtually constant even with varying loads. Conventional LDO regulators use a pnp pass element, the base current of which is directly proportional to the load current through the regulator ( $I_B = I_C/\beta$ ). The TPS701xx uses a PMOS transistor to pass current; because the gate of the PMOS is voltage-driven, operating current is low and stable over the full load range.

## Pin Functions

### Enable

The  $\overline{\text{EN}}$  terminal is an input that enables or shuts down the device. If  $\overline{\text{EN}}$  is at a voltage high signal, the device is in shutdown mode. When  $\overline{\text{EN}}$  goes to voltage low, the device is enabled.

### Sequence

The SEQ terminal is an input that programs which output voltage ( $V_{\text{OUT1}}$  or  $V_{\text{OUT2}}$ ) is turned on first. When the device is enabled and the SEQ terminal is pulled high or left open,  $V_{\text{OUT2}}$  turns on first and  $V_{\text{OUT1}}$  remains off until  $V_{\text{OUT2}}$  reaches approximately 83% of its regulated output voltage. At that time,  $V_{\text{OUT1}}$  is turned on. If  $V_{\text{OUT2}}$  is pulled below 83% (for example, in an overload condition)  $V_{\text{OUT1}}$  is turned off. These terminals have a 6- $\mu$ A pullup current to  $V_{\text{IN1}}$ .

Pulling the SEQ terminal low reverses the power-up order and  $V_{\text{OUT1}}$  is turned on first. For detailed timing diagrams, refer to [Figure 40](#) through [Figure 44](#).

### Power-Good

The PG1 is an open drain, active high output terminal that indicates the status of the  $V_{OUT1}$  regulator. When the  $V_{OUT1}$  reaches 95% of its regulated voltage, PG1 will go to a high impedance state. It will go to a low impedance state when it is pulled below 95% (for example, during an overload condition) of its regulated voltage. The open drain output of the PG1 terminal requires a pull-up resistor.

### Manual Reset Pins ( $\overline{MR1}$ and $\overline{MR2}$ )

$\overline{MR1}$  and  $\overline{MR2}$  are active low input terminals used to trigger a reset condition. When either  $\overline{MR1}$  or  $\overline{MR2}$  is pulled to logic low, a POR (RESET) will occur. These terminals have a  $6\mu\text{A}$  pull-up current to  $V_{IN1}$ .

### Sense ( $V_{SENSE1}$ , $V_{SENSE2}$ )

The sense terminals of fixed-output options must be connected to the regulator output, and the connection should be as short as possible. Internally, sense connects to high-impedance, wide-bandwidth amplifiers through a resistor-divider network and noise pickup feeds through to the regulator output. It is essential to route the sense connection in such a way to minimize or avoid noise pickup. Adding RC networks between the  $V_{SENSE}$  terminals and  $V_{OUT}$  terminals to filter noise is not recommended because these networks can cause the regulators to oscillate.

### FB1 and FB2

FB1 and FB2 are input terminals used for adjustable-output devices and must be connected to the external feedback resistor divider. FB1 and FB2 connections should be as short as possible. It is essential to route them in such a way as to minimize or avoid noise pickup. Adding RC networks between the FB terminals and  $V_{OUT}$  terminals to filter noise is not recommended because these networks cause the regulators to oscillate.

### RESET Indicator

The TPS701xx features a  $\overline{\text{RESET}}$  (SVS, POR, or Power-On Reset).  $\overline{\text{RESET}}$  can be used to drive power-on reset circuitry or a low-battery indicator.  $\overline{\text{RESET}}$  is an active low, open drain output that indicates the status of the  $V_{OUT2}$  regulator and both manual reset pins ( $\overline{MR1}$  and  $\overline{MR2}$ ). When  $V_{OUT2}$  exceeds 95% of its regulated voltage, and  $\overline{MR1}$  and  $\overline{MR2}$  are in the high impedance state,  $\overline{\text{RESET}}$  will go to a high-impedance state after 120ms delay.  $\overline{\text{RESET}}$  will go to a low-impedance state when  $V_{OUT2}$  is pulled below 95% (for example, an overload condition) of its regulated voltage. To monitor  $V_{OUT1}$ , the PG1 output pin can be connected to  $\overline{MR1}$  or  $\overline{MR2}$ . The open drain output of the  $\overline{\text{RESET}}$  terminal requires a pullup resistor. If  $\overline{\text{RESET}}$  is not used, it can be left floating.

### $V_{IN1}$ and $V_{IN2}$

$V_{IN1}$  and  $V_{IN2}$  are input to the regulators. **Internal bias voltages are powered by  $V_{IN1}$ .**

### $V_{OUT1}$ and $V_{OUT2}$

$V_{OUT1}$  and  $V_{OUT2}$  are output terminals of the LDO.



TYPICAL CHARACTERISTICS

Table 2. Table of Graphs

			FIGURE
$V_O$	Output voltage	vs Output current	Figure 1 to Figure 3
		vs Temperature	Figure 4 to Figure 7
	Ground current	vs Junction temperature	Figure 8
PSRR	Power-supply rejection ratio	vs Frequency	Figure 9 to Figure 12
		Output spectral noise density	vs Frequency
$Z_O$	Output impedance	vs Frequency	Figure 17 to Figure 20
		vs Temperature	Figure 21 and Figure 22
		vs Input voltage	Figure 23 and Figure 24
	Load transient response		Figure 25 and Figure 26
	Line transient response		Figure 27 and Figure 28
$V_O$	Output voltage and enable voltage	vs Time (start-up)	Figure 29 and Figure 30
	Equivalent series resistance	vs Output current	Figure 31 to Figure 38
	Test circuit for typical regions of stability (equivalent series resistance) performance		Figure 39

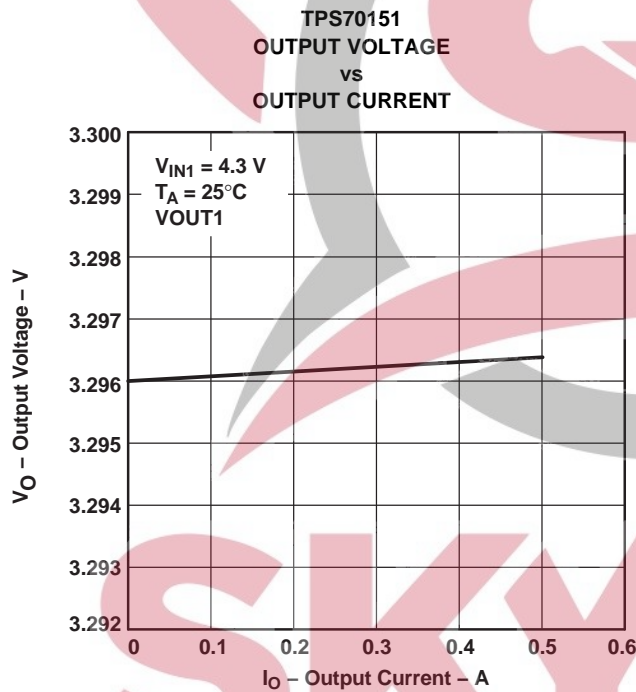

Figure 1.

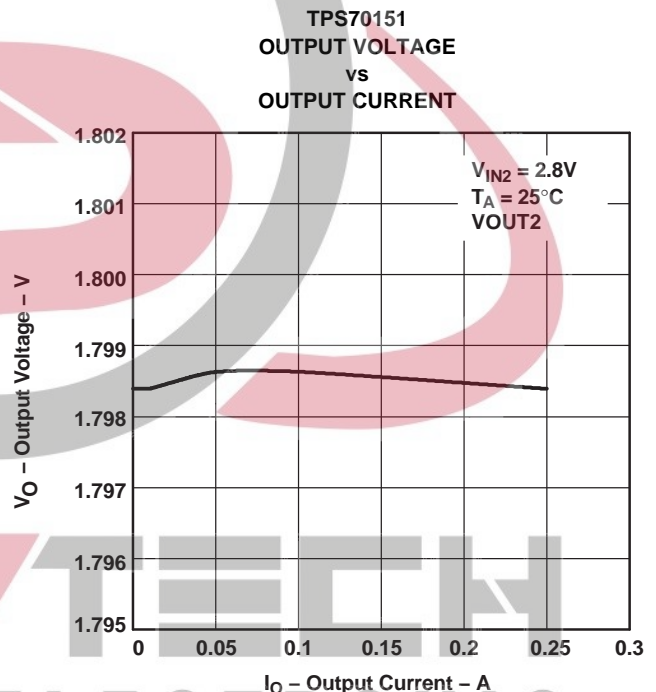

Figure 2.

TPS70145  
OUTPUT VOLTAGE  
vs  
OUTPUT CURRENT

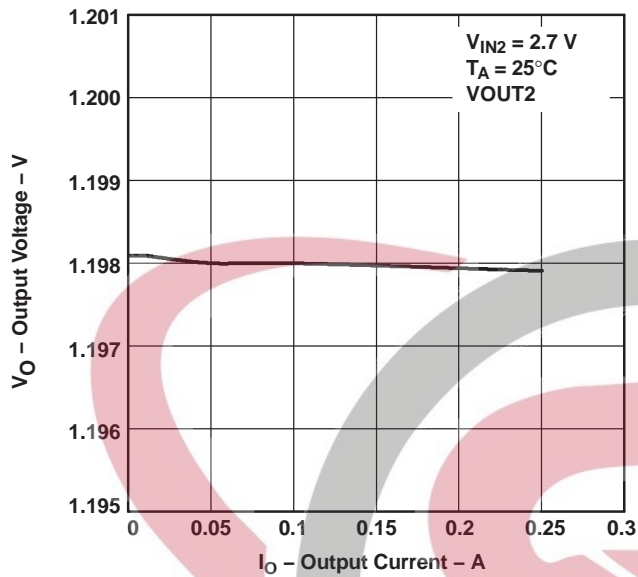

Figure 3.

TPS70151  
OUTPUT VOLTAGE  
vs  
TEMPERATURE

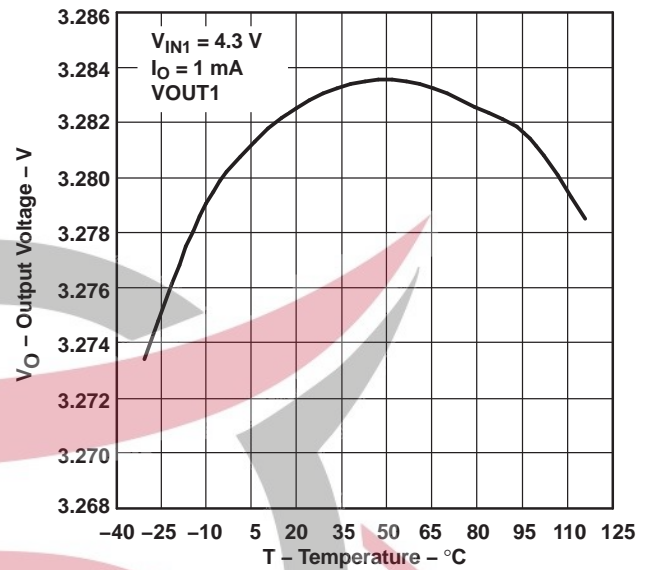

Figure 4.

TPS70151  
OUTPUT VOLTAGE  
vs  
TEMPERATURE

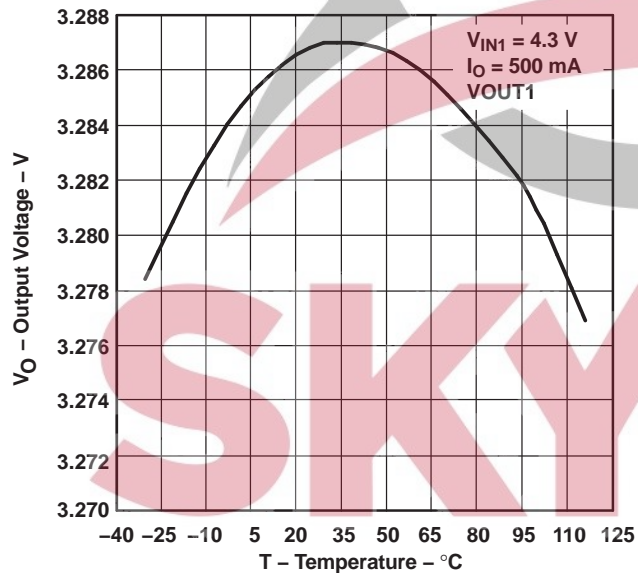

Figure 5.

TPS70151  
OUTPUT VOLTAGE  
vs  
TEMPERATURE

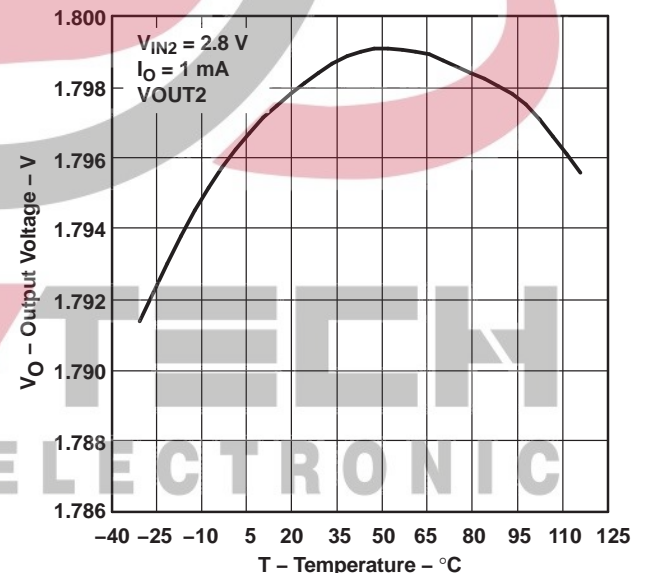

Figure 6.

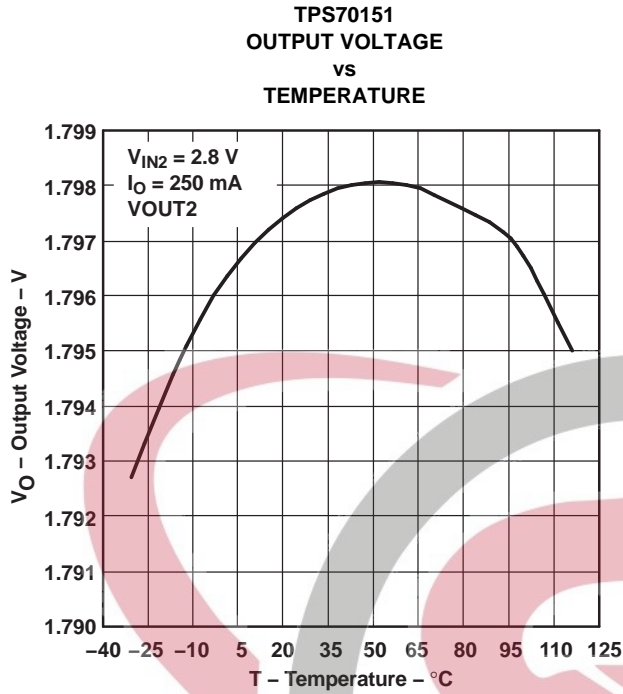

Figure 7.

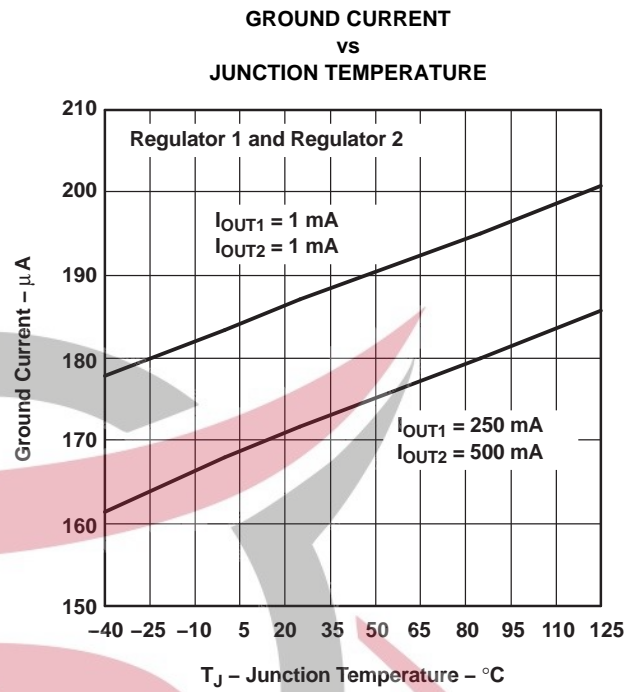

Figure 8.

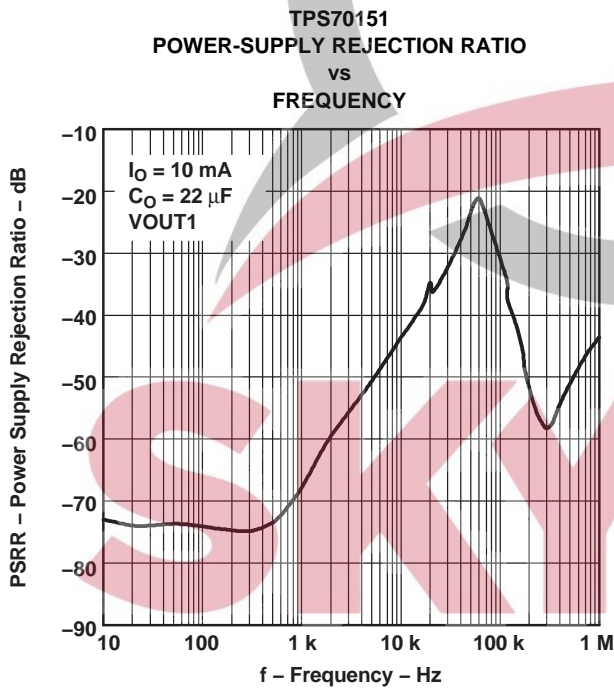

Figure 9.

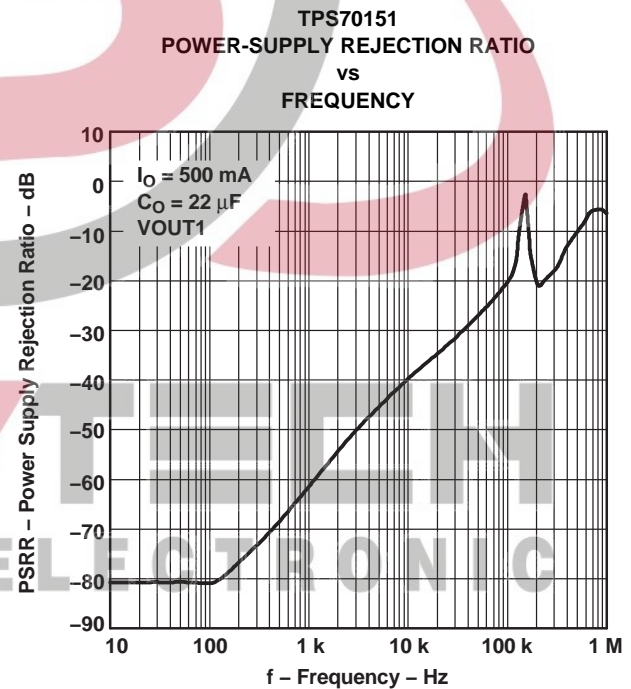

Figure 10.

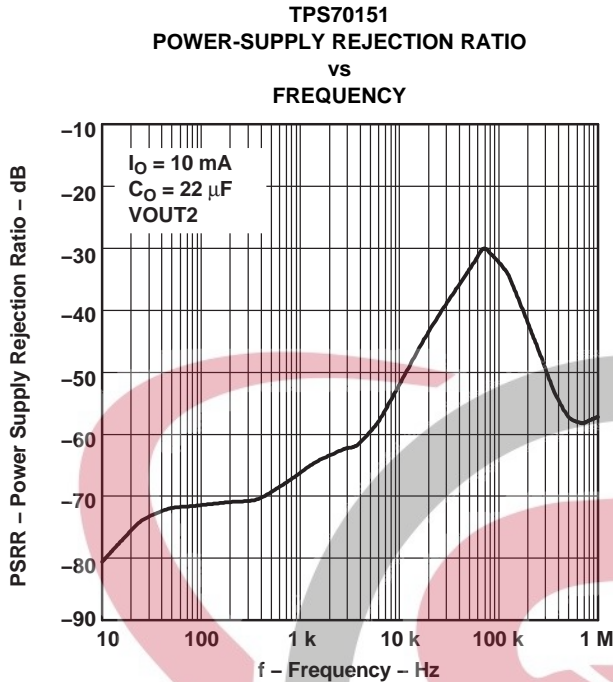

Figure 11.

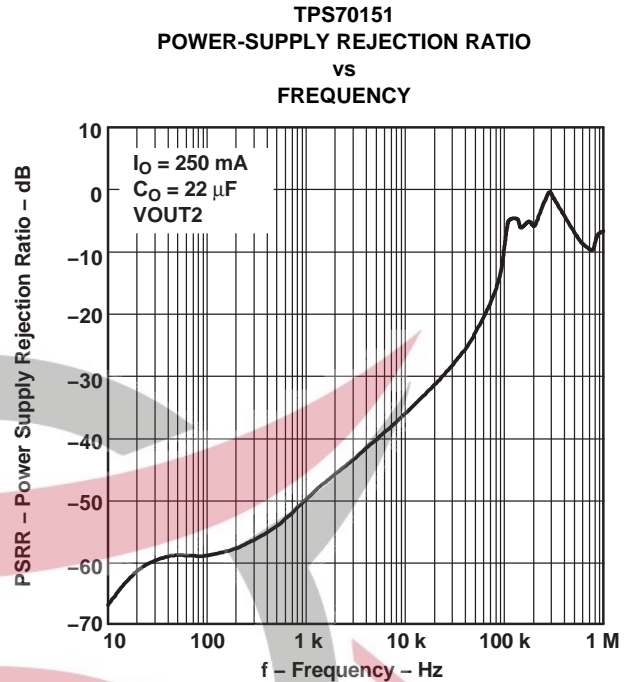

Figure 12.

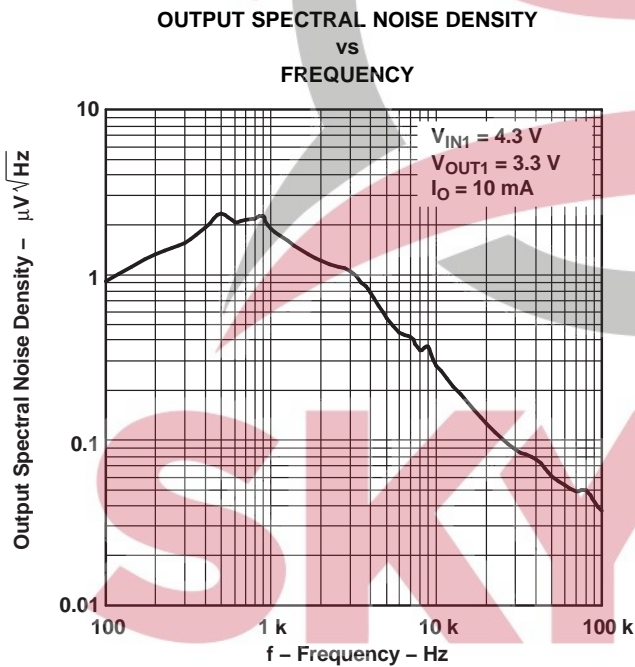

Figure 13.

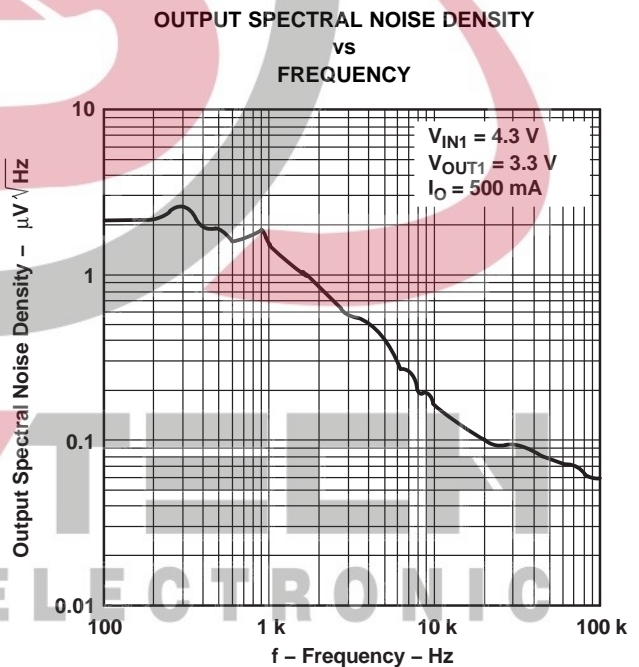

Figure 14.

OUTPUT SPECTRAL NOISE DENSITY  
 vs  
 FREQUENCY

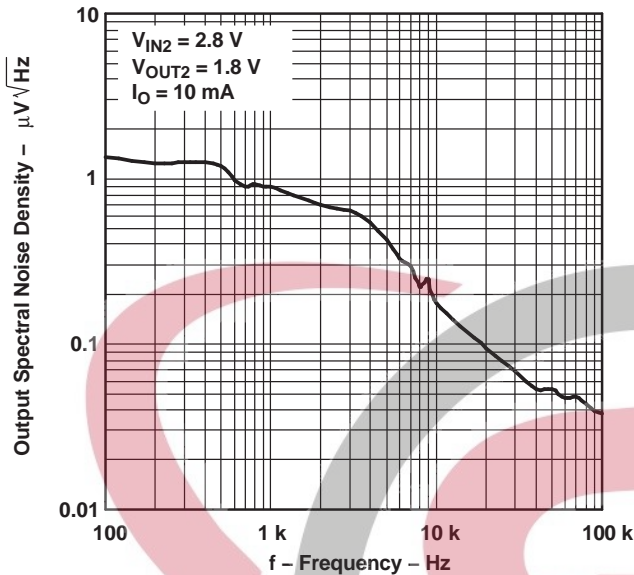

Figure 15.

OUTPUT SPECTRAL NOISE DENSITY  
 vs  
 FREQUENCY

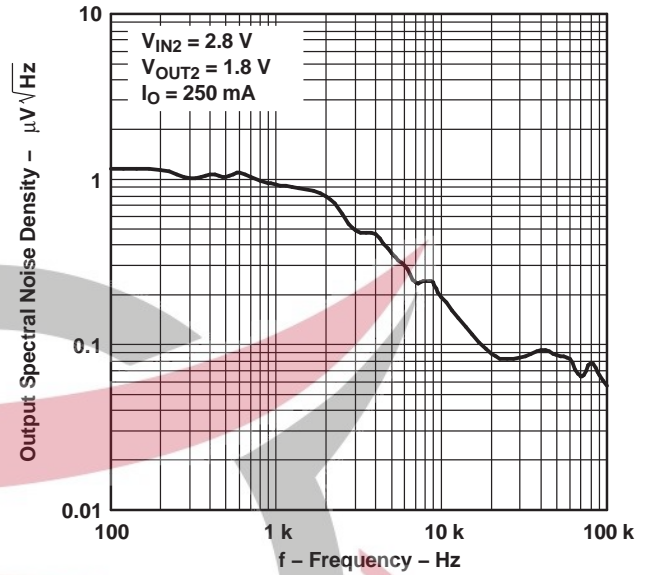

Figure 16.

OUTPUT IMPEDANCE  
 vs  
 FREQUENCY

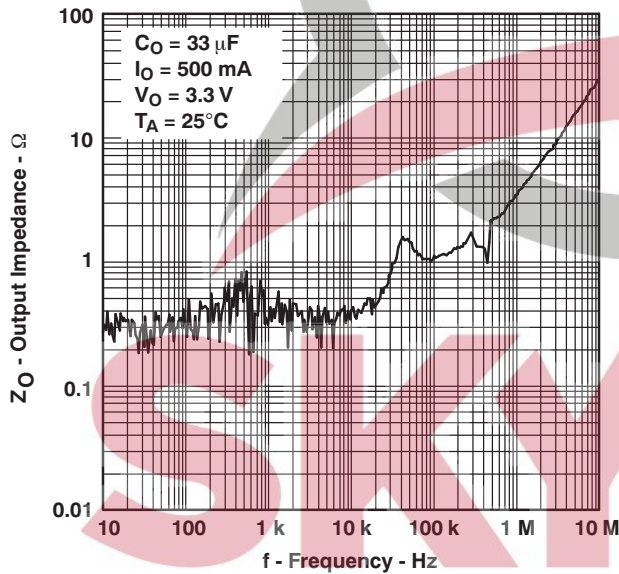

Figure 17.

OUTPUT IMPEDANCE  
 vs  
 FREQUENCY

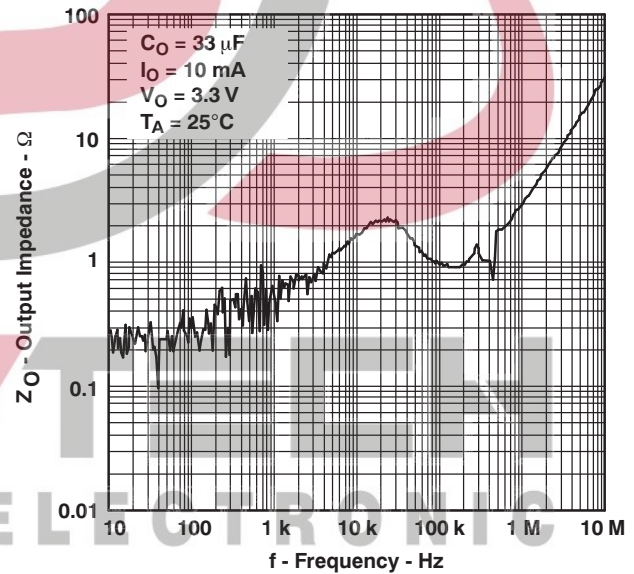
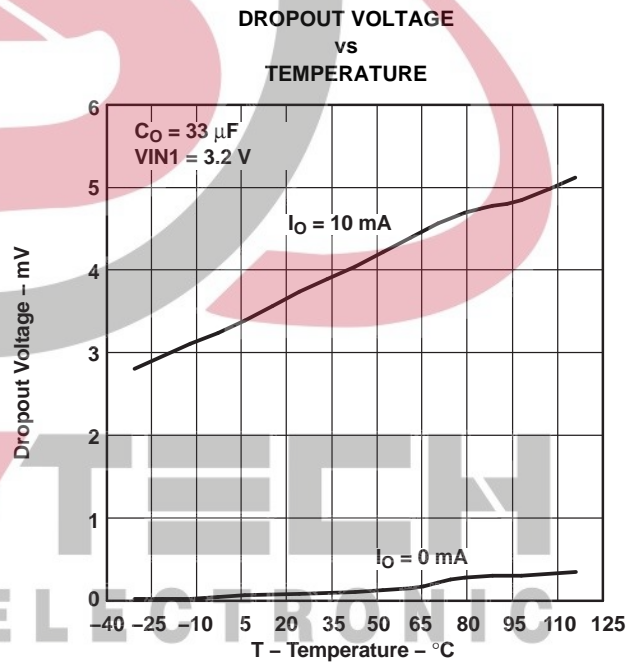
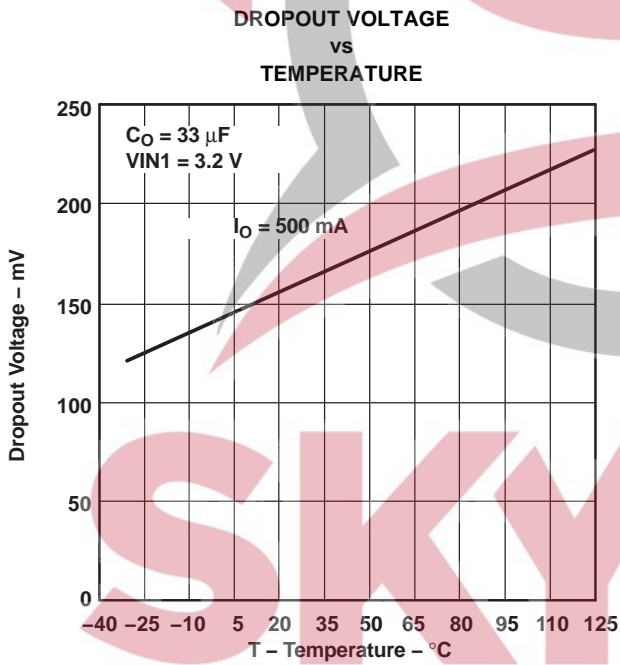
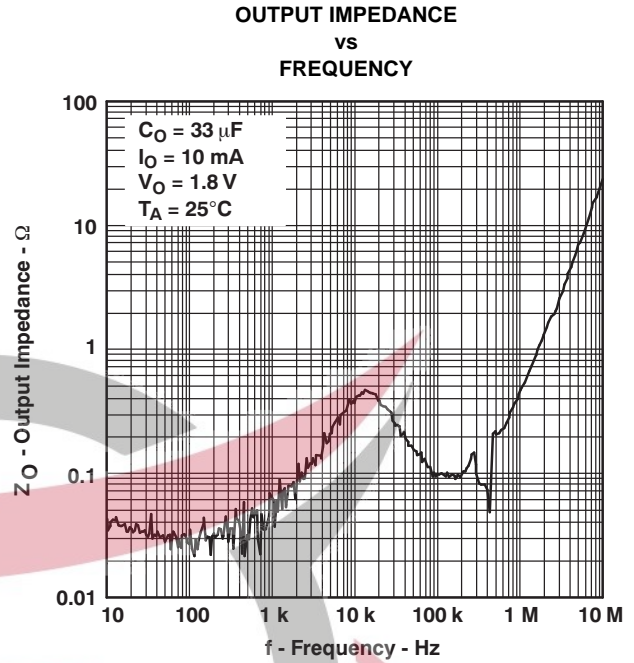
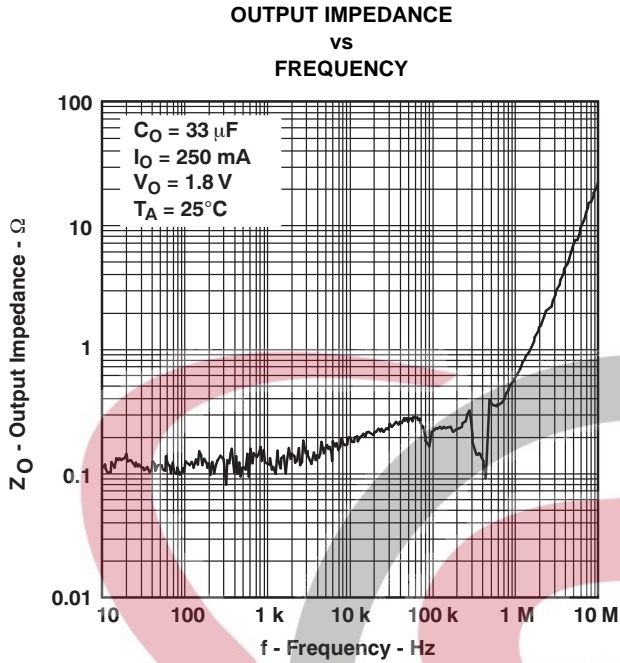

Figure 18.





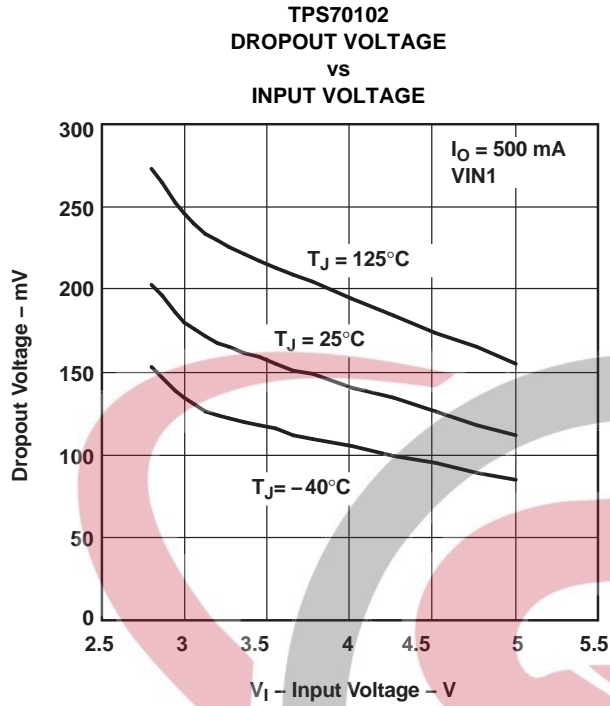

Figure 23.

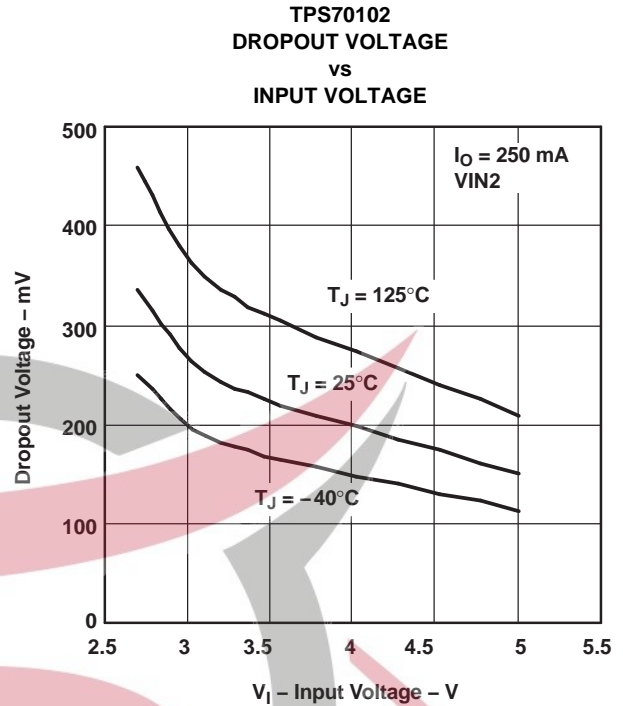

Figure 24.

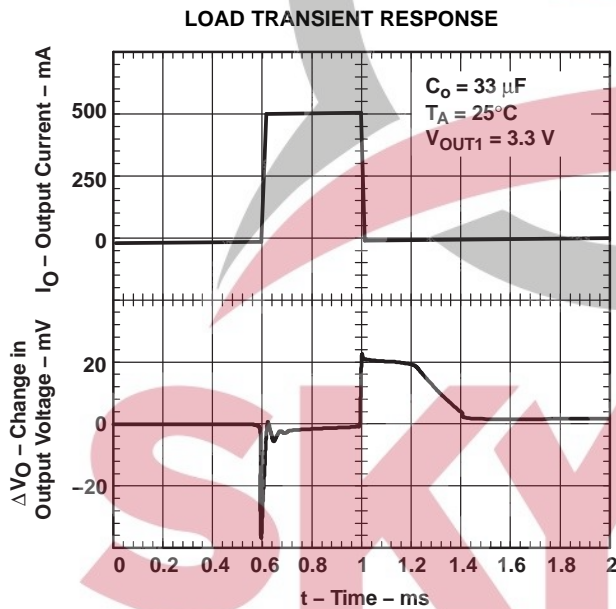

Figure 25.

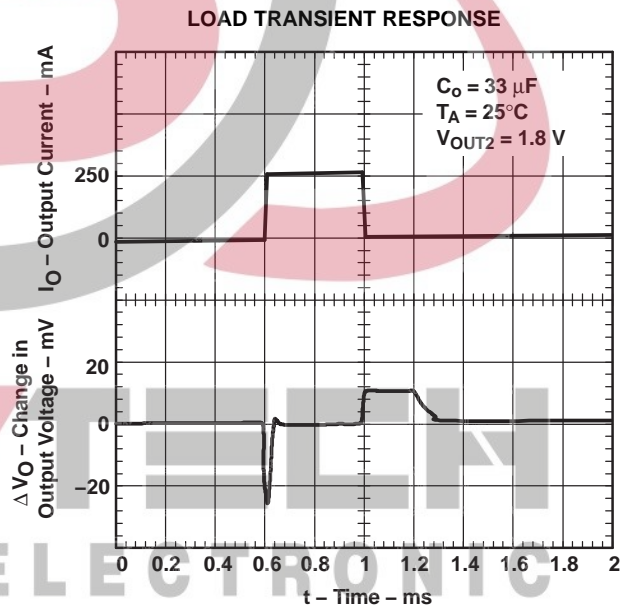

Figure 26.

LINE TRANSIENT RESPONSE

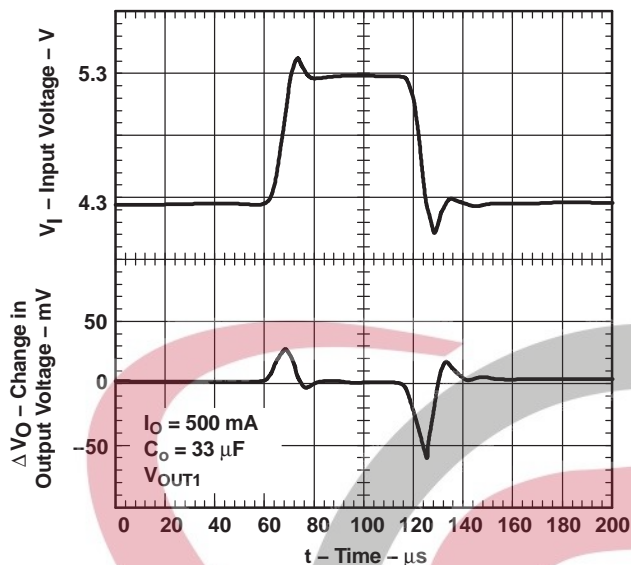

Figure 27.

LINE TRANSIENT RESPONSE

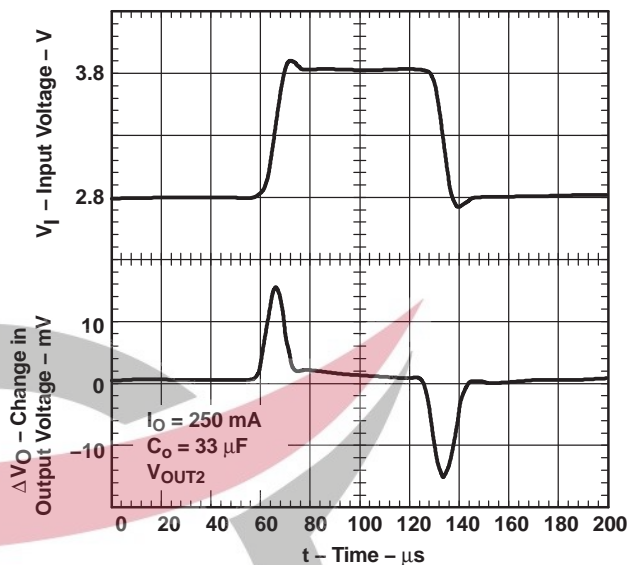

Figure 28.

OUTPUT VOLTAGE AND ENABLE VOLTAGE  
vs  
TIME (START-UP)

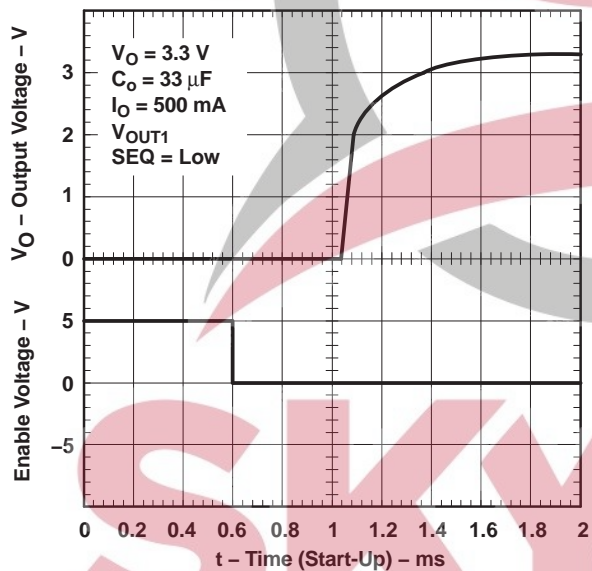

Figure 29.

OUTPUT VOLTAGE AND ENABLE VOLTAGE  
vs  
TIME (START-UP)

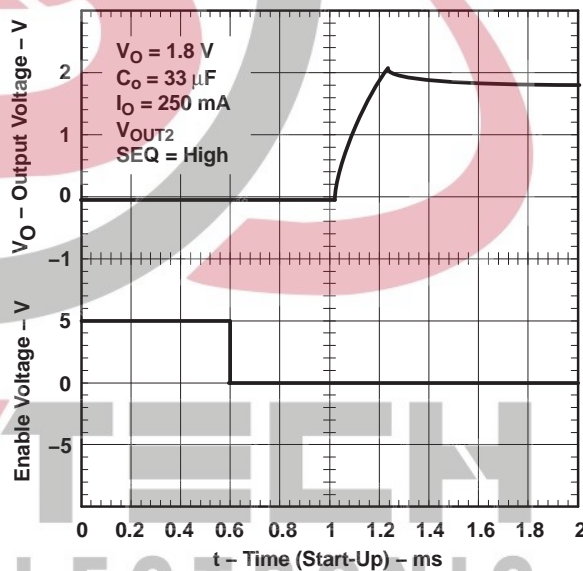

Figure 30.

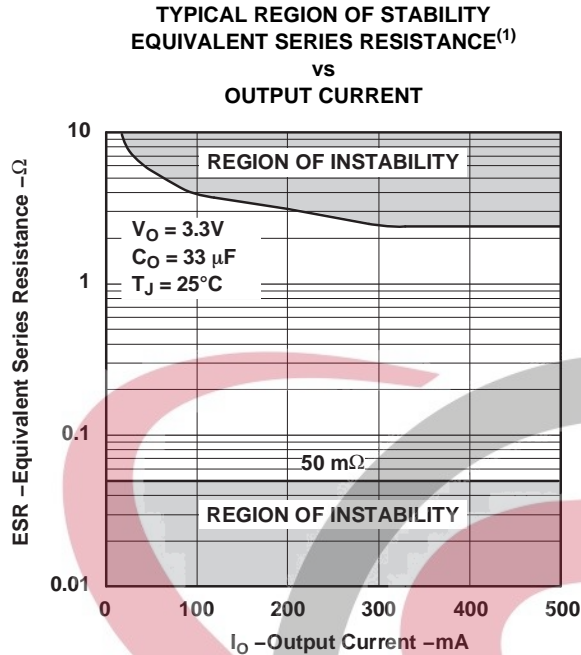

Figure 31.

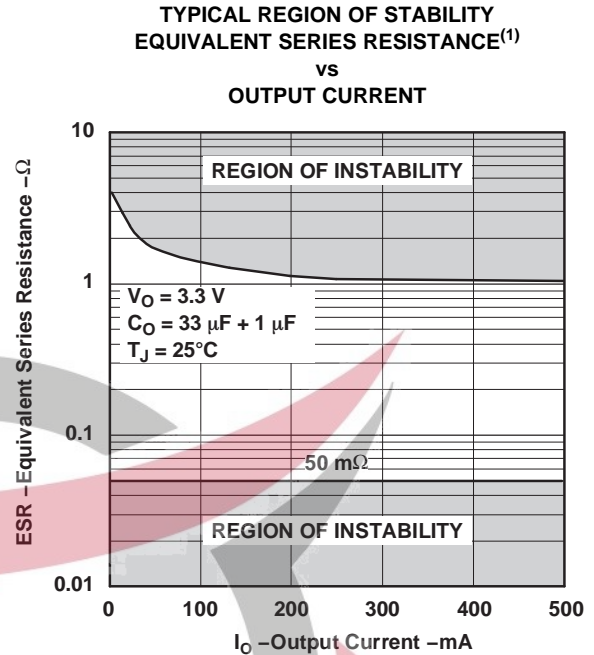

Figure 32.

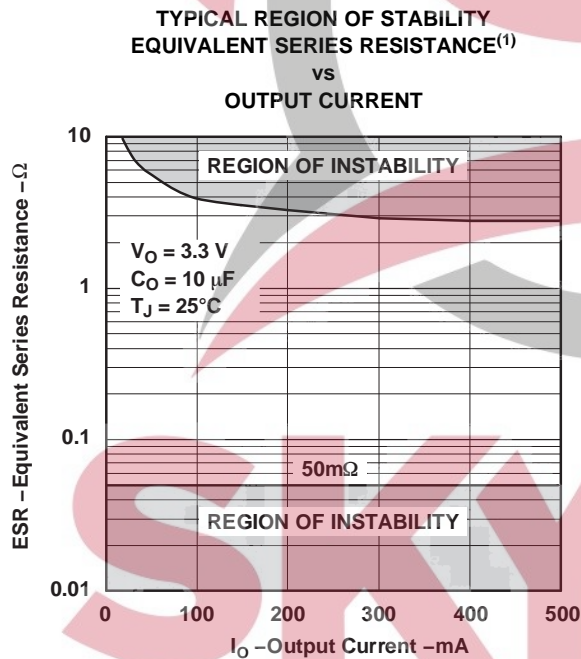

Figure 33.

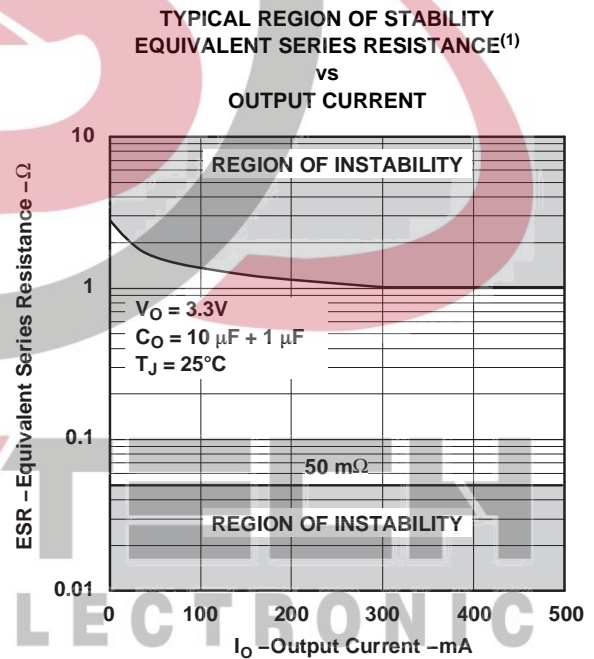

Figure 34.

<sup>(1)</sup> Equivalent series resistance (ESR) refers to the total series resistance, including the ESR of the capacitor, any series resistance added externally, and PWB trace resistance to  $C_O$ .

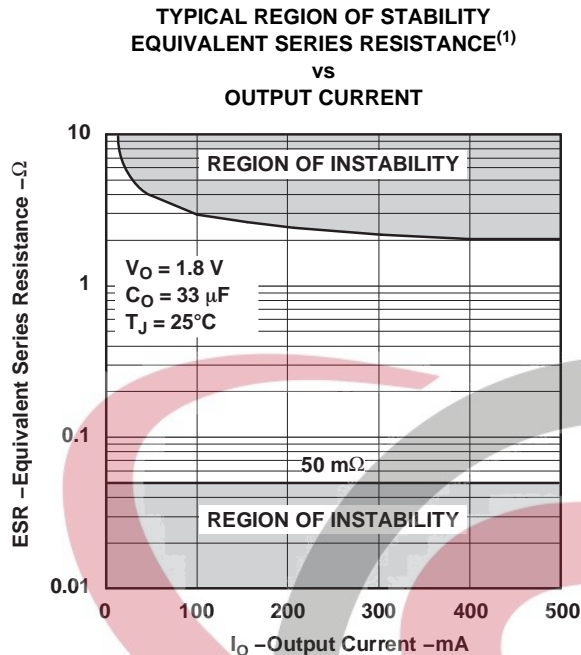

Figure 35.

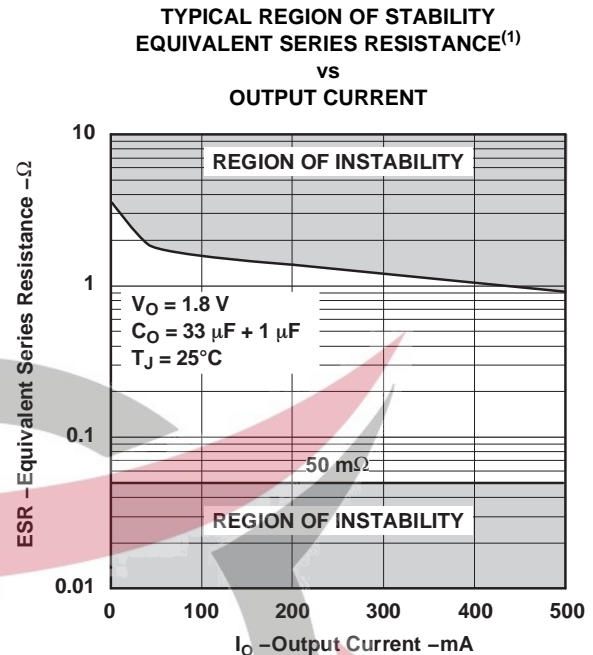

Figure 36.

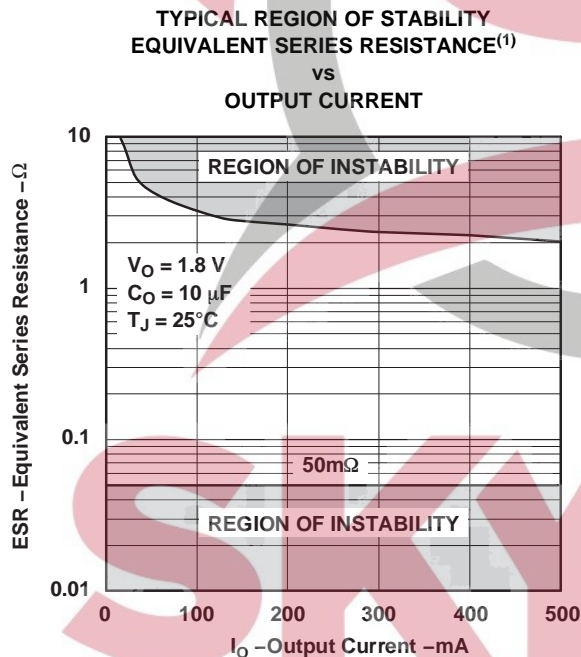

Figure 37.

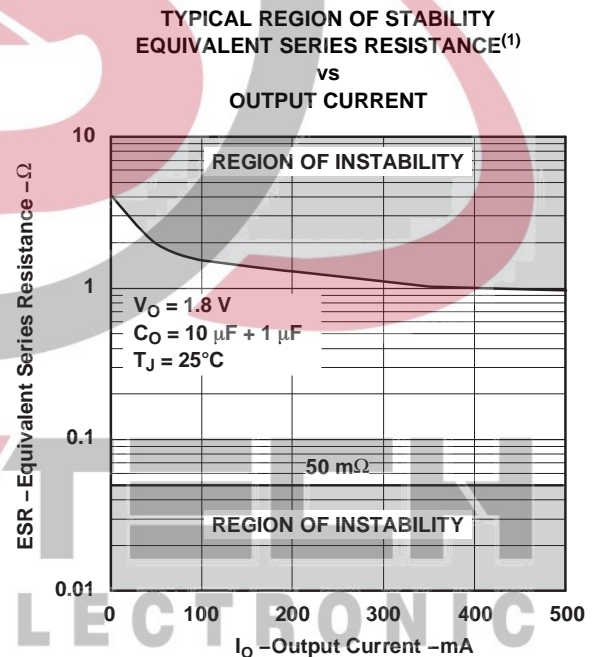

Figure 38.

<sup>(1)</sup> Equivalent series resistance (ESR) refers to the total series resistance, including the ESR of the capacitor, any series resistance added externally, and PWB trace resistance to  $C_O$ .

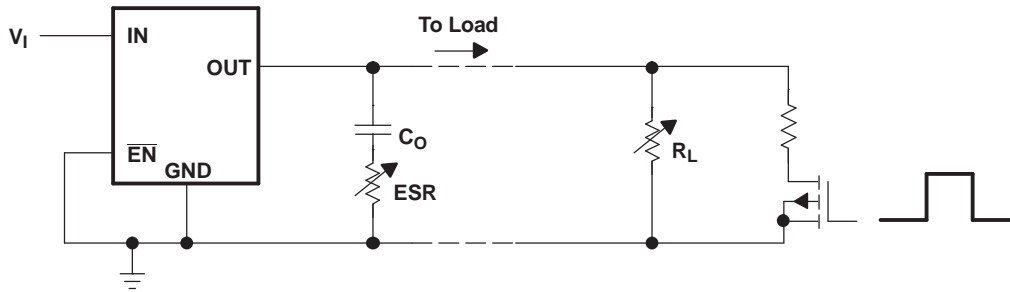

Figure 39. Test Circuit for Typical Regions of Stability



## APPLICATION INFORMATION

### Sequencing Timing Diagrams

This section provides a number of timing diagrams showing how this device functions in different configurations.

Application condition:  $\overline{MR2}$  is tied to PG1,  $V_{IN1}$  and  $V_{IN2}$  are tied to the same input voltage, the SEQ pin is tied to logic low and the device is toggled with the enable ( $\overline{EN}$ ) function.

When the device is enabled ( $\overline{EN}$  is pulled low),  $V_{OUT1}$  turns on first and  $V_{OUT2}$  remains off until  $V_{OUT1}$  reaches approximately 83% of its regulated output voltage. At that time,  $V_{OUT2}$  is turned on. When  $V_{OUT1}$  reaches 95% of its regulated output, PG1 turns on (active high). Since  $\overline{MR2}$  is connected to PG1 for this application, it follows PG1. When  $V_{OUT2}$  reaches 95% of its regulated voltage, RESET switches to high voltage level after a 120ms delay (see Figure 40).

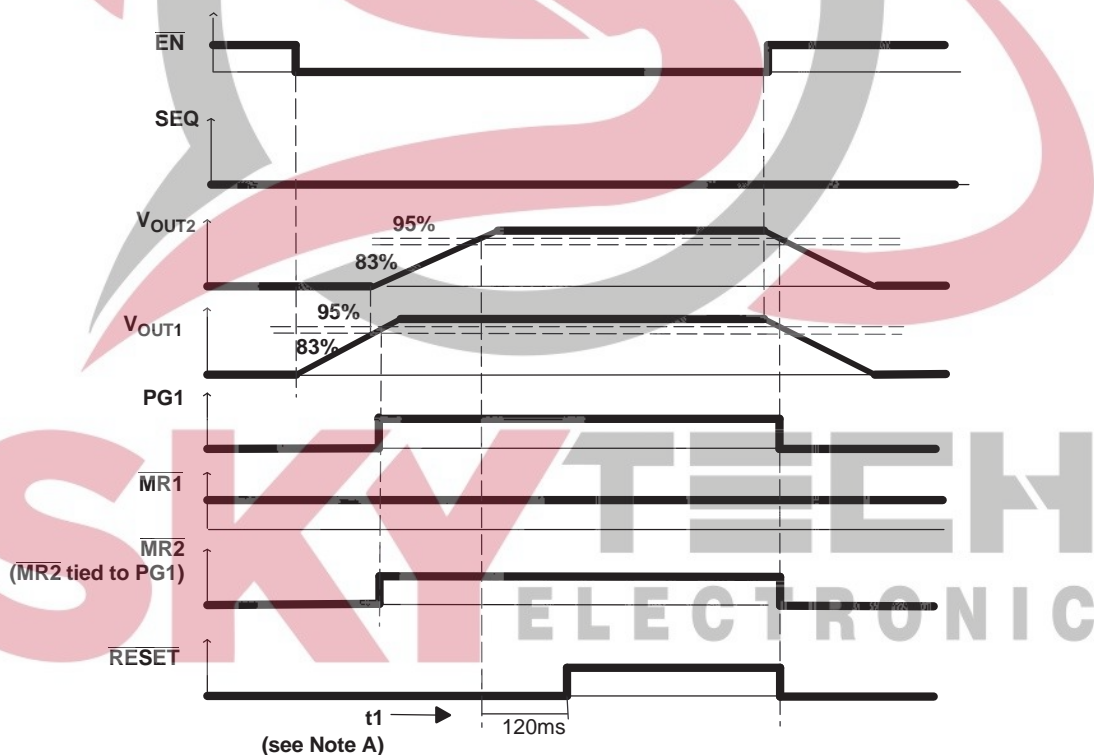
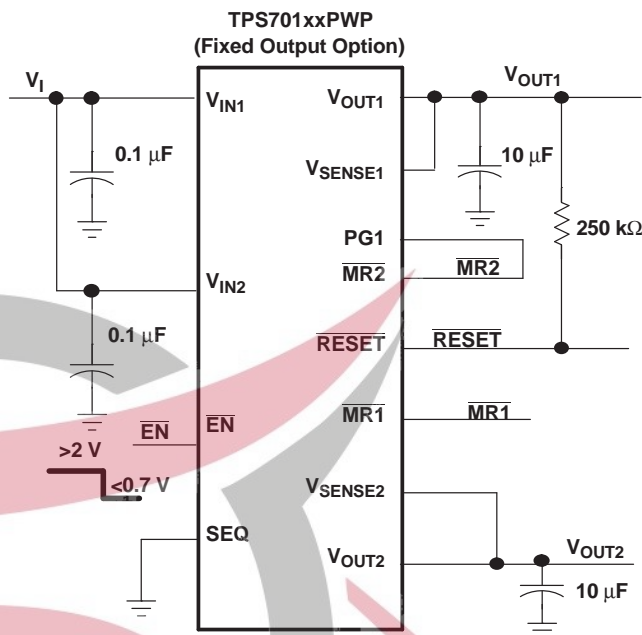

NOTE A:  $t_1$  – Time at which both  $V_{OUT1}$  and  $V_{OUT2}$  are greater than the PG1 thresholds and  $\overline{MR1}$  is logic high.

Figure 40. Timing when SEQ = Low

Application condition:  $\overline{MR2}$  is tied to PG1,  $V_{IN1}$  and  $V_{IN2}$  are tied to the same input voltage, the SEQ pin is tied to logic high and the device is toggled with the enable (EN) function.

When the device is enabled ( $\overline{EN}$  is pulled low),  $V_{OUT2}$  begins to power up. When it reaches 83% of its regulated voltage,  $V_{OUT1}$  begins to power up. PG1 turns on when  $V_{OUT1}$  reaches 95% of its regulated voltage, and since  $\overline{MR2}$  and PG1 are tied together,  $\overline{MR2}$  follows PG1. When  $V_{OUT1}$  reaches 95% of its regulated voltage, RESET switches to high voltage level after a 120ms delay (see Figure 41).

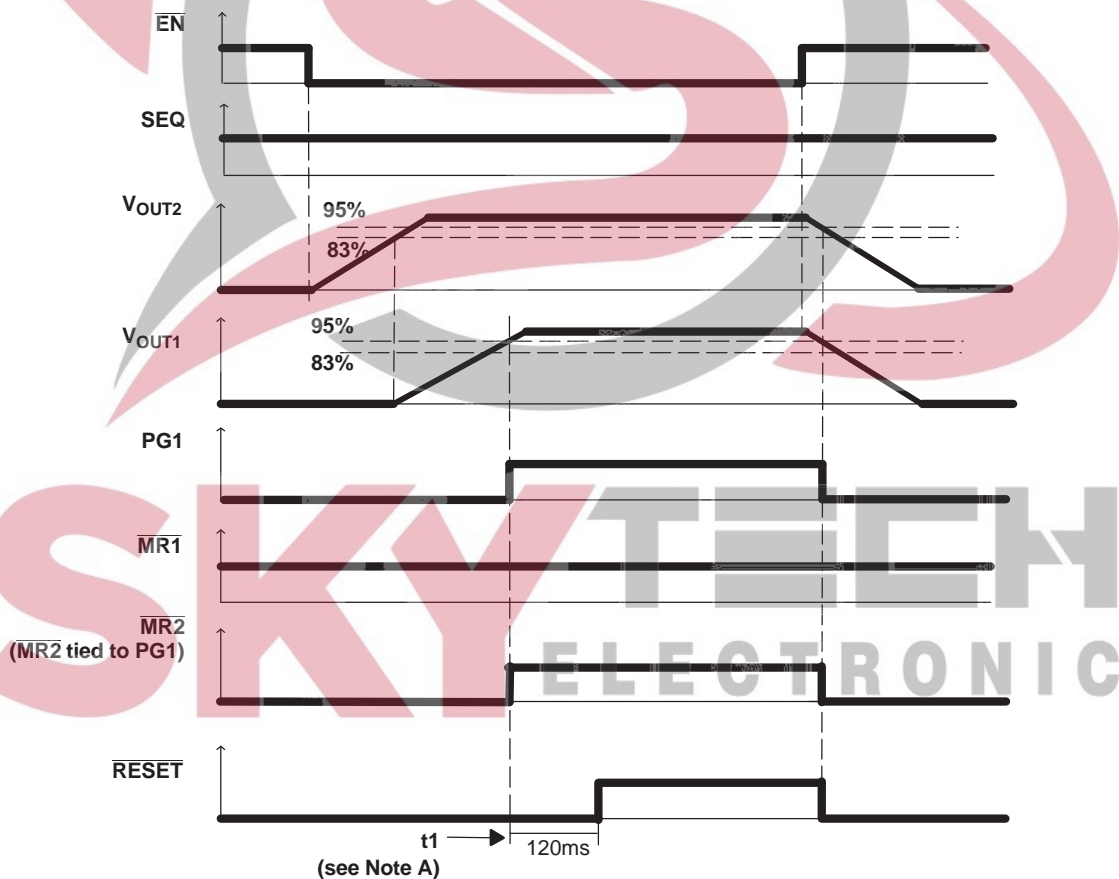
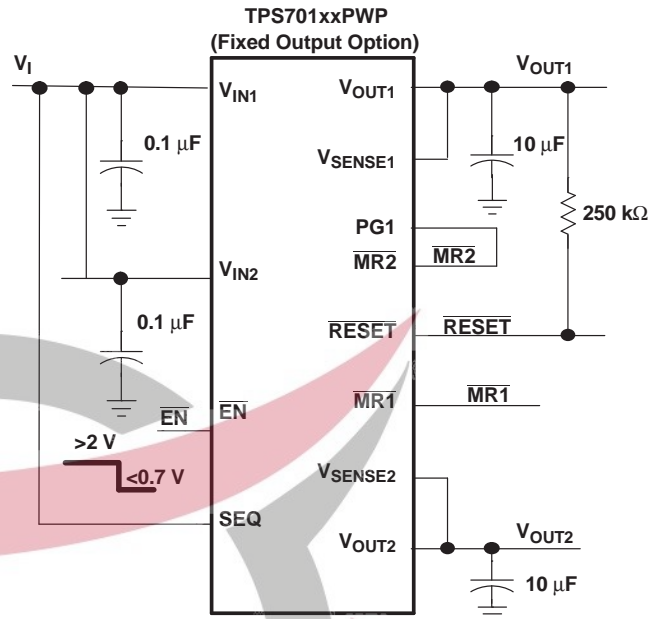

NOTE A:  $t_1$  – Time at which both  $V_{OUT1}$  and  $V_{OUT2}$  are greater than the PG1 thresholds and  $\overline{MR1}$  is logic high.

Figure 41. Timing when SEQ = High



Application condition:  $\overline{MR2}$  is tied to PG1,  $V_{IN1}$  and  $V_{IN2}$  are tied to the same input voltage, the SEQ pin is tied to logic high and MR1 is toggled.

When the device is enabled ( $\overline{EN}$  is pulled low),  $V_{OUT2}$  begins to power up. When it reaches 83% of its regulated voltage,  $V_{OUT1}$  begins to power up. PG1 turns on when  $V_{OUT1}$  reaches to 95% of its regulated voltage, and since MR2 and PG1 are tied together, MR2 follows PG1. When  $V_{OUT1}$  reaches 95% of its regulated voltage, the RESET switches to high voltage level after a 120ms delay. When MR1 is pulled low, it causes RESET to go low, but the regulators remains in regulation (see Figure 42).

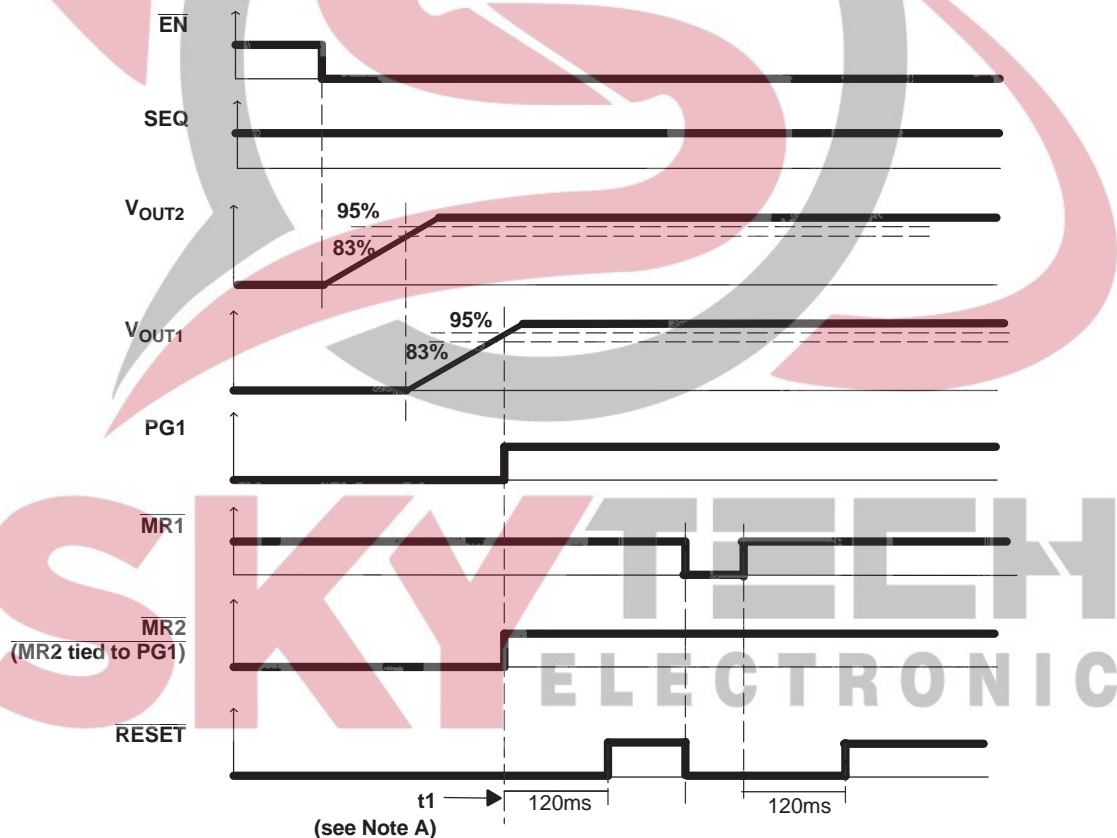
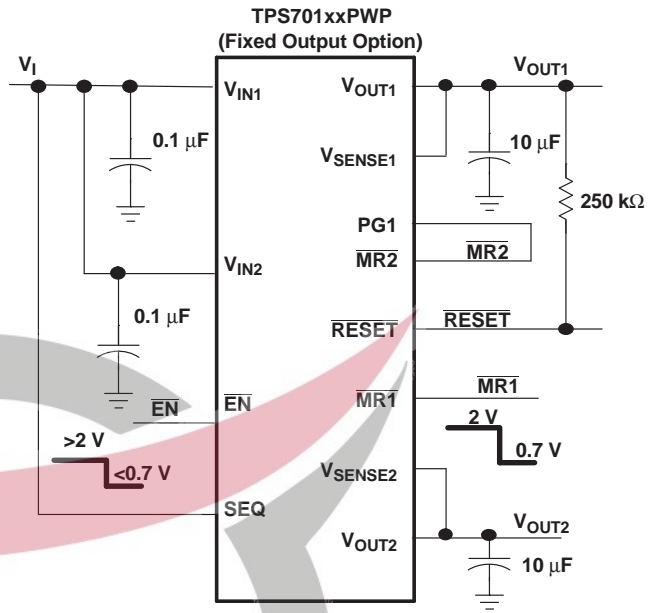

NOTE A:  $t_1$  – Time at which both  $V_{OUT1}$  and  $V_{OUT2}$  are greater than the PG1 thresholds and  $\overline{MR1}$  is logic high.

Figure 42. Timing when  $\overline{MR1}$  is Toggled

Application condition:  $\overline{MR2}$  is tied to PG1,  $V_{IN1}$  and  $V_{IN2}$  are tied to the same input voltage, the SEQ pin is tied to logic high and  $V_{OUT1}$  faults out.

$V_{OUT2}$  begins to power up when the device is enabled ( $\overline{EN}$  is pulled low). When  $V_{OUT2}$  reaches 83% of its regulated voltage, then  $V_{OUT1}$  begins to power up. When  $V_{OUT1}$  reaches 95% of its regulated voltage, PG1 turns on and  $\overline{RESET}$  switches to high voltage level after a 120ms delay. When  $V_{OUT1}$  faults out,  $V_{OUT2}$  remains powered on because the SEQ pin is high. PG1 is tied to  $\overline{MR2}$  and both change state to logic low.  $\overline{RESET}$  is driven by  $\overline{MR2}$  and goes to logic low when  $V_{OUT1}$  faults out (see Figure 43).

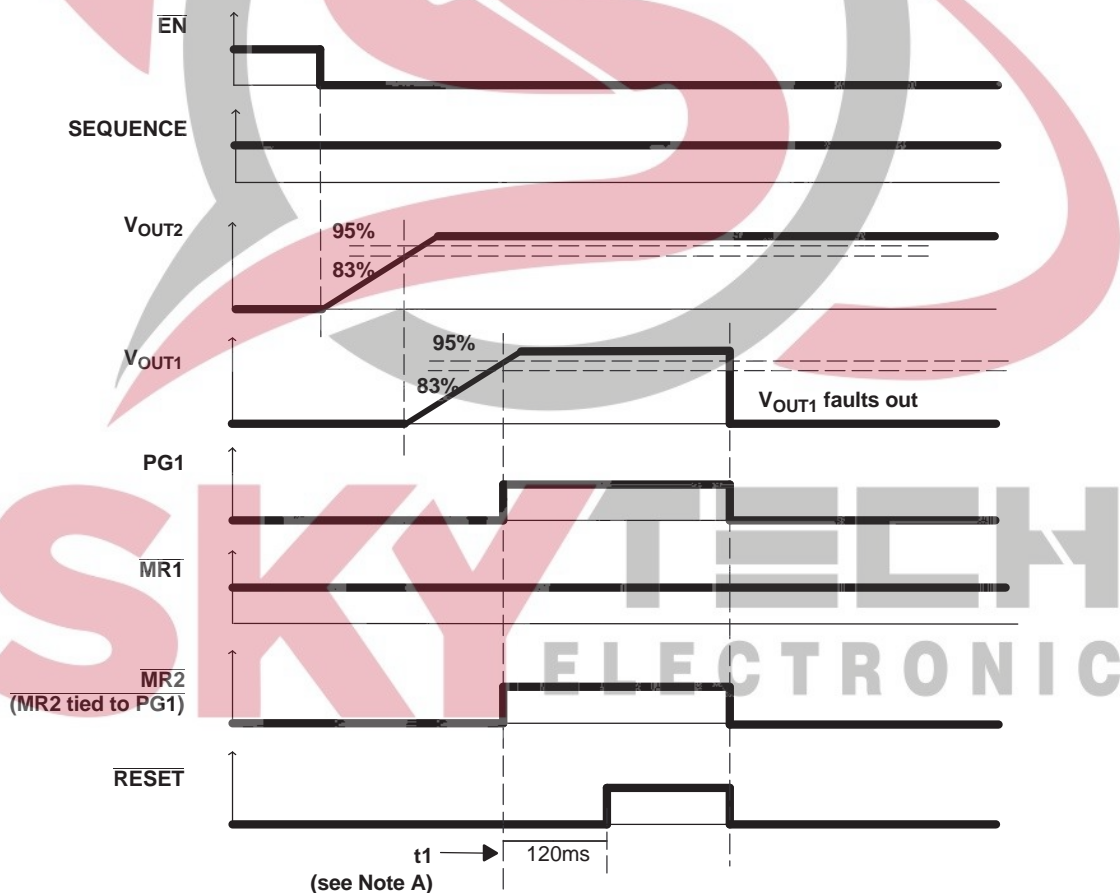
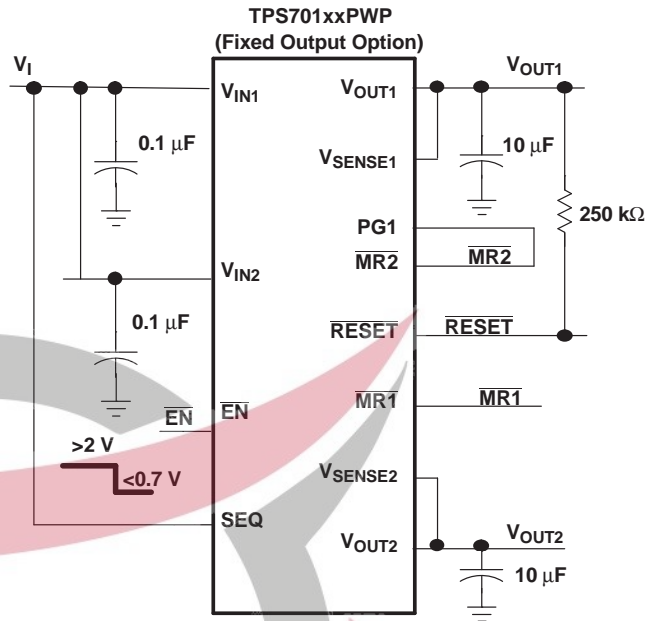

NOTE A:  $t_1$  – Time at which both  $V_{OUT1}$  and  $V_{OUT2}$  are greater than the PG1 thresholds and  $\overline{MR1}$  is logic high.

Figure 43. Timing when  $V_{OUT1}$  Faults Out

Application condition:  $\overline{\text{MR2}}$  is tied to PG1,  $V_{\text{IN1}}$  and  $V_{\text{IN2}}$  are tied to same input voltage, the SEQ is tied to logic high, the device is enabled, and  $V_{\text{OUT2}}$  faults out.

$V_{\text{OUT2}}$  begins to power up when the device is enabled (EN is pulled low). When  $V_{\text{OUT2}}$  reaches 83% of its regulated voltage,  $V_{\text{OUT1}}$  begins to power up. When  $V_{\text{OUT1}}$  reaches 95% of its regulated voltage, PG1 turns on and  $\overline{\text{RESET}}$  switches to high voltage level after a 120ms delay. When  $V_{\text{OUT2}}$  faults out,  $V_{\text{OUT1}}$  is powered down because SEQ is high. PG1 is tied to  $\overline{\text{MR2}}$  and both change state to logic low.  $\overline{\text{RESET}}$  goes low when  $V_{\text{OUT2}}$  faults out (see Figure 44).

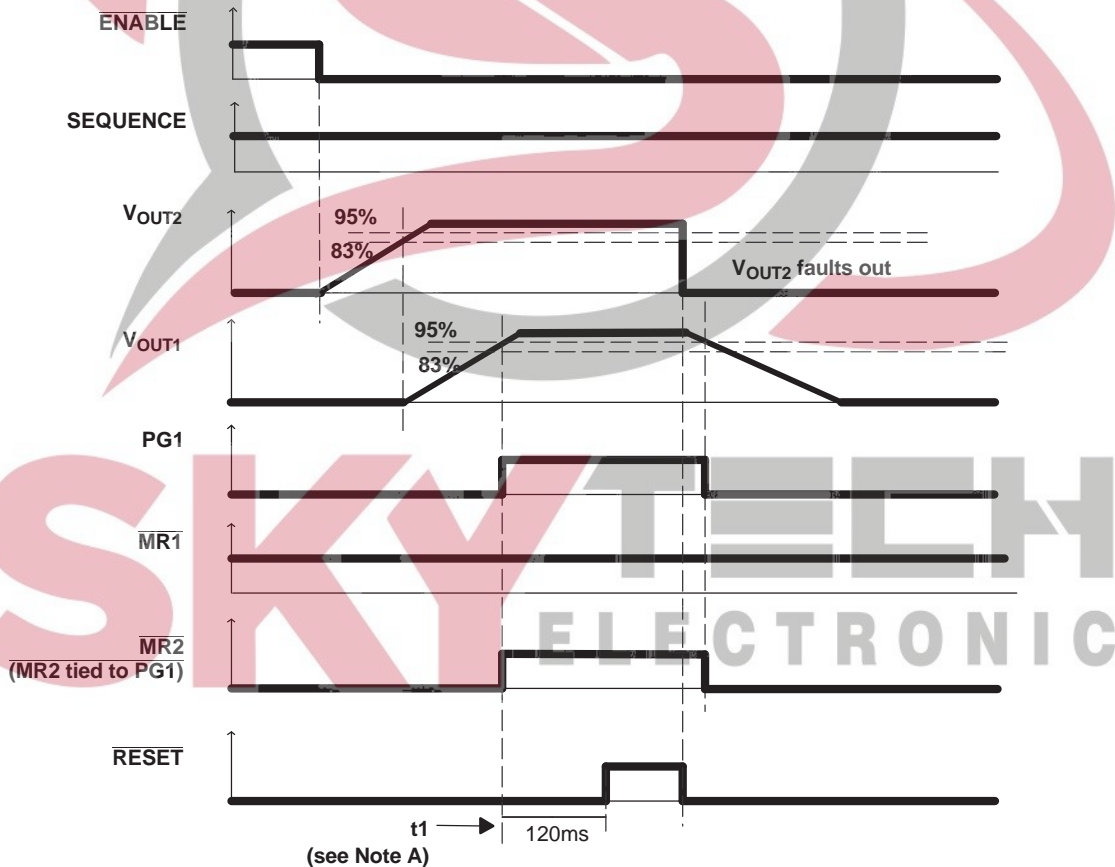
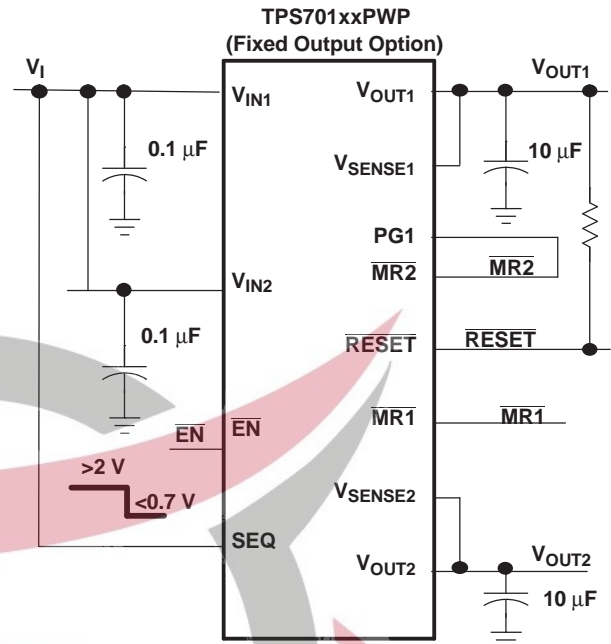

NOTE A:  $t_1$  – Time at which both  $V_{\text{OUT1}}$  and  $V_{\text{OUT2}}$  are greater than the PG1 thresholds and  $\overline{\text{MR1}}$  is logic high.

Figure 44. Timing when  $V_{\text{OUT2}}$  Faults Out

### Split Voltage DSP Application

Figure 45 shows a typical application where the TPS70151 is powering up a DSP. In this application, by grounding the SEQ pin,  $V_{OUT1}$  (I/O) is powered up first, and then  $V_{OUT2}$  (core).

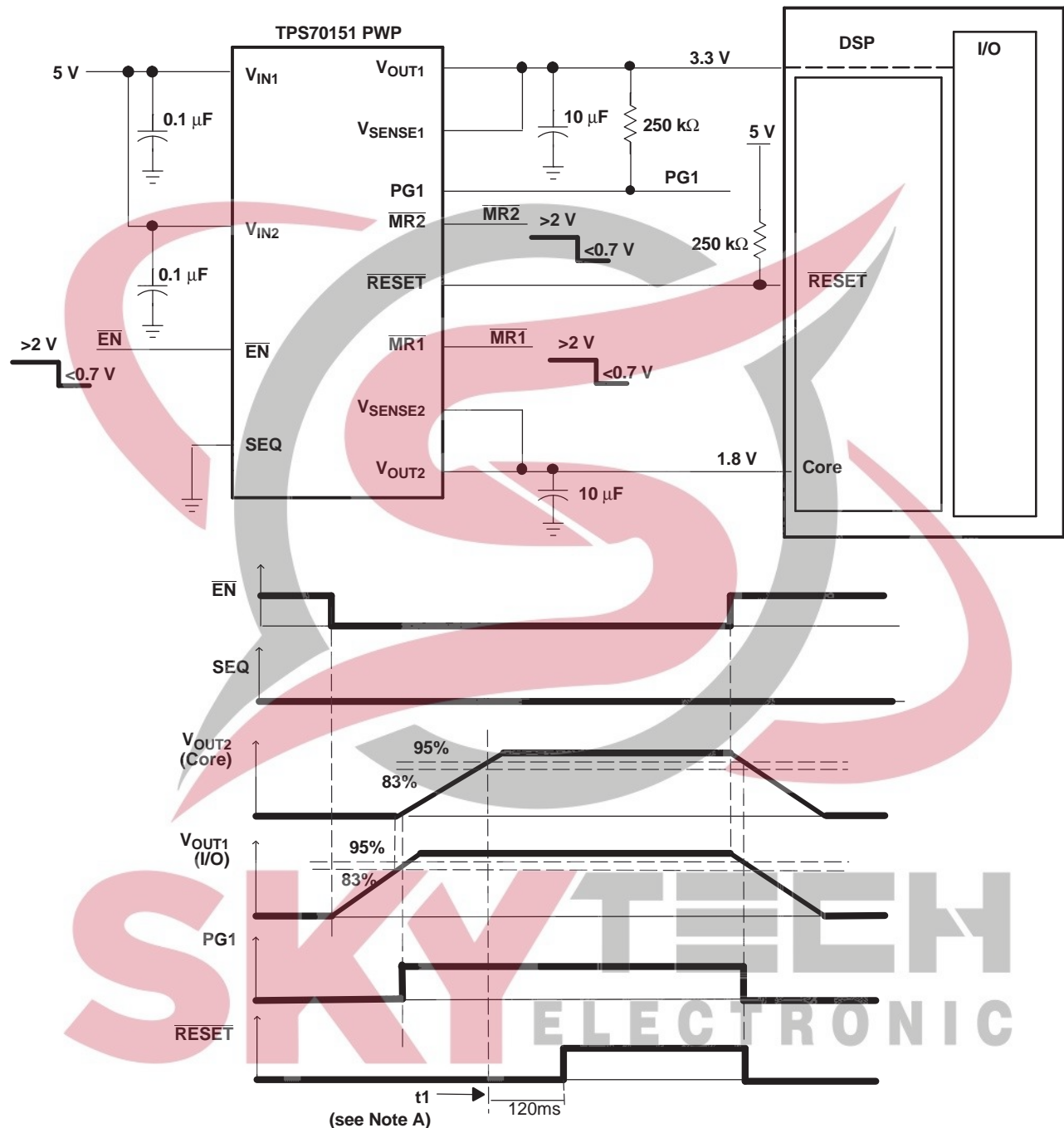

NOTE A:  $t_1$  – Time at which both  $V_{OUT1}$  and  $V_{OUT2}$  are greater than the PG1 thresholds and  $\overline{MR1}$  is logic high.

Figure 45. Application Timing Diagram (SEQ = Low)

Figure 46 shows a typical application where the TPS70151 is powering up a DSP. In this application, by pulling up the SEQ pin,  $V_{OUT2}$  (core) is powered up first, and then  $V_{OUT1}$  (I/O).

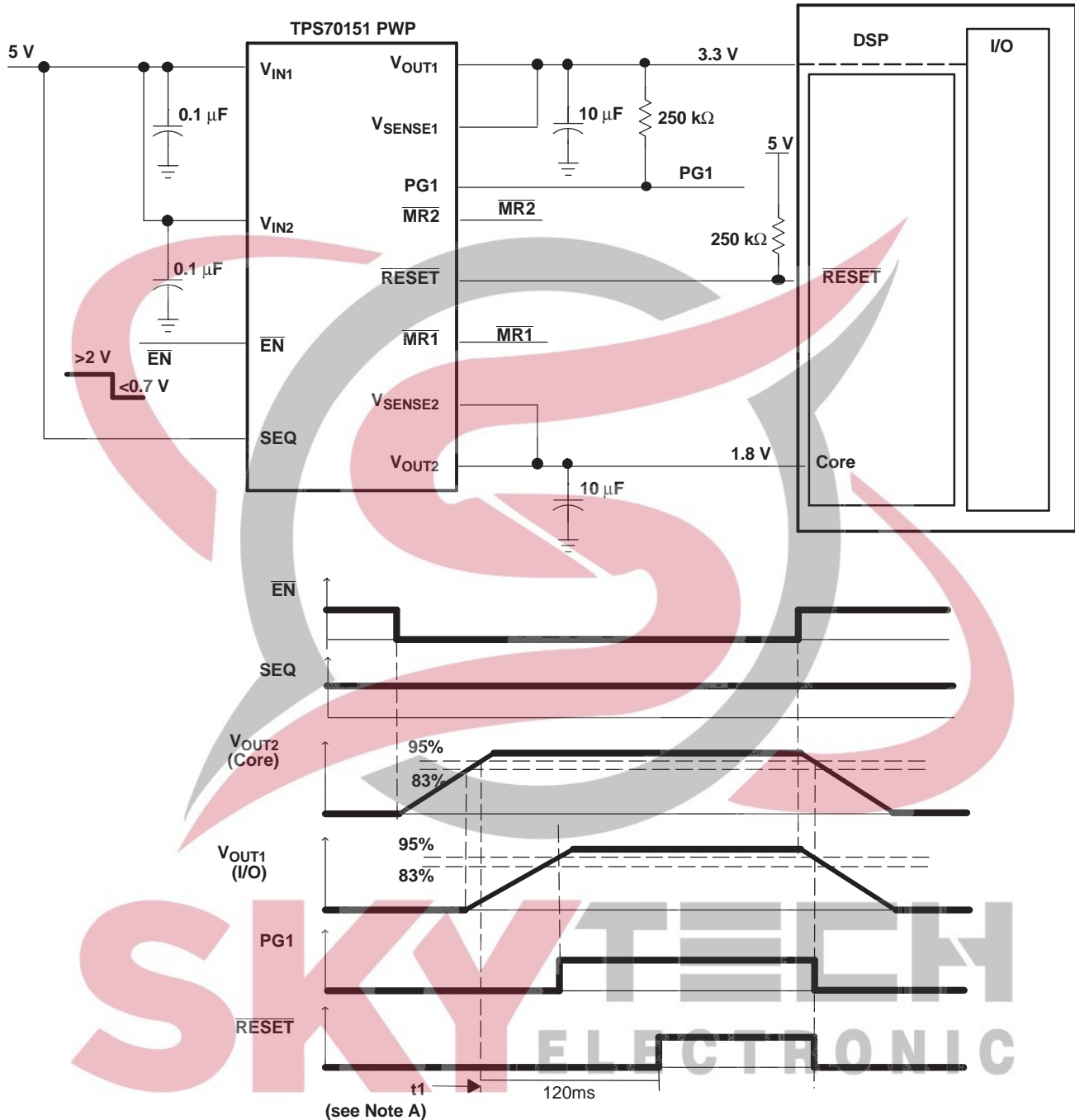

NOTE A:  $t_1$  – Time at which both  $V_{OUT1}$  and  $V_{OUT2}$  are greater than the PG1 thresholds and  $\overline{MR1}$  is logic high.

Figure 46. Application Timing Diagram (SEQ = High)

### Input Capacitor

For a typical application, an input bypass capacitor (0.1µF to 1µF) is recommended. This capacitor filters any high-frequency noise generated in the line. For fast transient conditions where droop at the input of the LDO may occur because of high inrush current, it is recommended to place a larger capacitor at the input as well. The size of this capacitor depends on the output current and response time of the main power supply, as well as the distance to the  $V_I$  pins of the LDO.

## Output Capacitor

As with most LDO regulators, the TPS701xx requires an output capacitor connected between OUT and GND to stabilize the internal control loop. The minimum recommended capacitance value is 10 $\mu$ F and the ESR (equivalent series resistance) must be between 50m $\Omega$  and 2.5 $\Omega$ . Capacitor values 10 $\mu$ F or larger are acceptable, provided the ESR is less than 2.5 $\Omega$ . Solid tantalum electrolytic, aluminum electrolytic, and multilayer ceramic capacitors are all suitable, provided they meet the requirements described above. Larger capacitors provide a wider range of stability and better load transient response. Table 3 provides a partial listing of surface-mount capacitors suitable for use with the TPS701xx for fast transient response application.

This information, along with the ESR graphs, is included to assist in selection of suitable capacitance for the user application. When necessary to achieve low height requirements along with high output current and/or high load capacitance, several higher ESR capacitors can be used in parallel to meet the guidelines above.

**Table 3. Partial Listing of TPS701xx-Compatible Surface-Mount Capacitors**

VALUE	MANUFACTURER	MAXIMUM ESR	MFR PART NO.
22 $\mu$ F	Kemet	345m $\Omega$	7495C226K0010AS
33 $\mu$ F	Sanyo	100m $\Omega$	10TPA33M
47 $\mu$ F	Sanyo	100m $\Omega$	6TPA47M
68 $\mu$ F	Sanyo	45m $\Omega$	10TPC68M

## ESR and Transient Response

LDOs typically require an external output capacitor for stability. In fast transient response applications, capacitors are used to support the load current while the LDO amplifier is responding. In most applications, one capacitor is used to support both functions.

Besides its capacitance, every capacitor also contains parasitic impedances. These parasitic impedances are resistive as well as inductive. The resistive impedance is called *equivalent series resistance* (ESR), and the inductive impedance is called *equivalent series inductance* (ESL). The equivalent schematic diagram of any capacitor can therefore be drawn as shown in Figure 47.



**Figure 47. ESR and ESL**

In most cases one can neglect the effect of inductive impedance ESL. Therefore, the following application focuses mainly on the parasitic resistance ESR.

**SKYTECH**  
 ELECTRONIC

Figure 48 shows the output capacitor and its parasitic resistances in a typical LDO output stage.

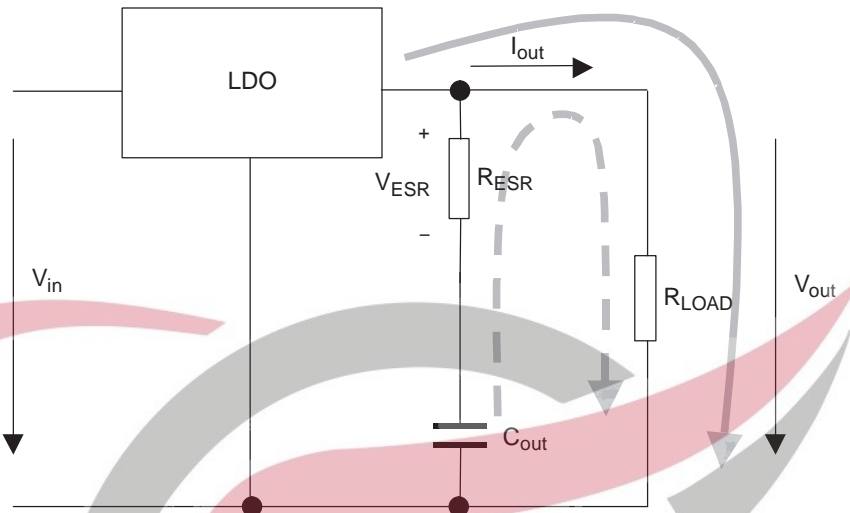
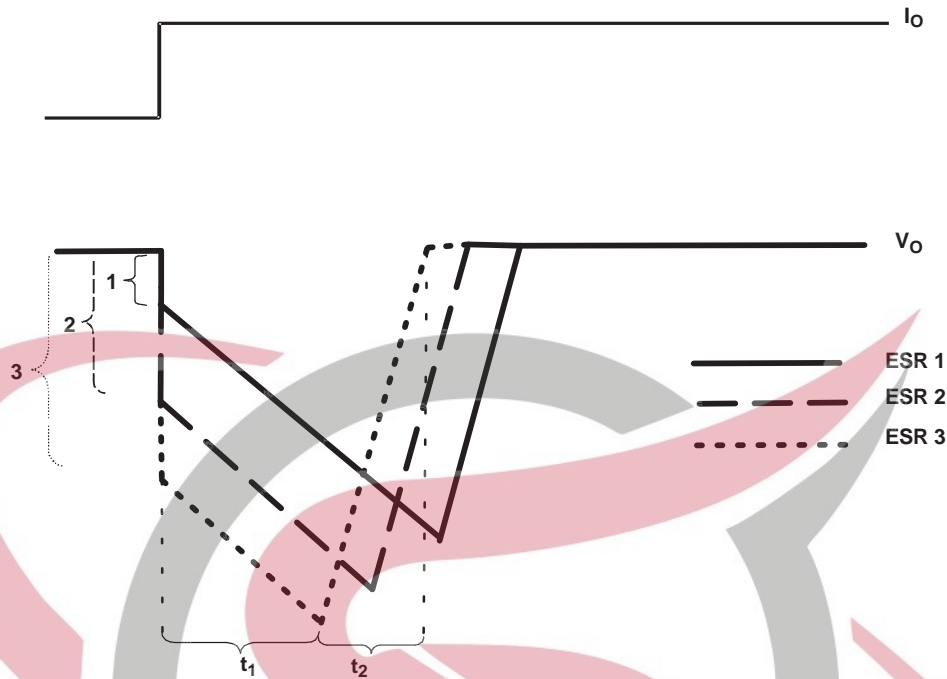

Figure 48. LDO Output Stage with Parasitic Resistances ESR

In steady state (dc state condition), the load current is supplied by the LDO (solid arrow) and the voltage across the capacitor is the same as the output voltage ( $V_{(CO)} = V_{OUT}$ ). This condition means no current is flowing into the  $C_O$  branch. If  $I_{OUT}$  suddenly increases (a transient condition), the following results occur:

- The LDO is not able to supply the sudden current need because of its response time ( $t_1$  in [Split Voltage DSP Application](#)). Therefore, capacitor  $C_O$  provides the current for the new load condition (dashed arrow).  $C_O$  now acts like a battery with an internal resistance, ESR. Depending on the current demand at the output, a voltage drop occurs at  $R_{ESR}$ . This voltage is shown as  $V_{ESR}$  in [Figure 44](#).
- When  $C_O$  is conducting current to the load, initial voltage at the load will be  $V_O = V_{(CO)} - V_{ESR}$ . As a result of the discharge of  $C_O$ , the output voltage  $V_O$  drops continuously until the response time  $t_1$  of the LDO is reached and the LDO resumes supplying the load. From this point, the output voltage starts rising again until it reaches the regulated voltage. This period is shown as  $t_2$  in [Figure 49](#).

SKYTECH  
ELECTRONIC



**Figure 49. Correlation of Different ESRs and Their Influence on the Regulation of  $V_O$  at a Load Step from Low-to-High Output Current**

Figure 49 also shows the impact of different ESRs on the output voltage. The left brackets show different levels of ESRs where number 1 displays the lowest and number 3 displays the highest ESR.

From above, the following conclusions can be drawn:

- The higher the ESR, the larger the droop at the beginning of load transient.
- The smaller the output capacitor, the faster the discharge time and the greater the voltage droop during the LDO response period.

### Conclusion

To minimize the transient output droop, capacitors must have a low ESR and be large enough to support the minimum output voltage requirement.

### Programming the TPS70102 Adjustable LDO Converter

The output voltage of the TPS70102 adjustable regulators are programmed using external resistor dividers as shown in Figure 50.

Resistors R1 and R2 should be chosen for approximately 50 $\mu$ A divider current. Lower value resistors can be used, but offer no inherent advantage and waste more power. Higher values should be avoided as leakage currents at the sense terminal increase the output voltage error. The recommended design procedure is to choose R2 = 30.1k $\Omega$  to set the divider current at approximately 50 $\mu$ A, and then calculate R1 using Equation 1:

$$R1 = \left( \frac{V_O}{V_{ref}} - 1 \right) \times R2 \quad (1)$$

where:

- $V_{REF} = 1.224V$  typ (the internal reference voltage)



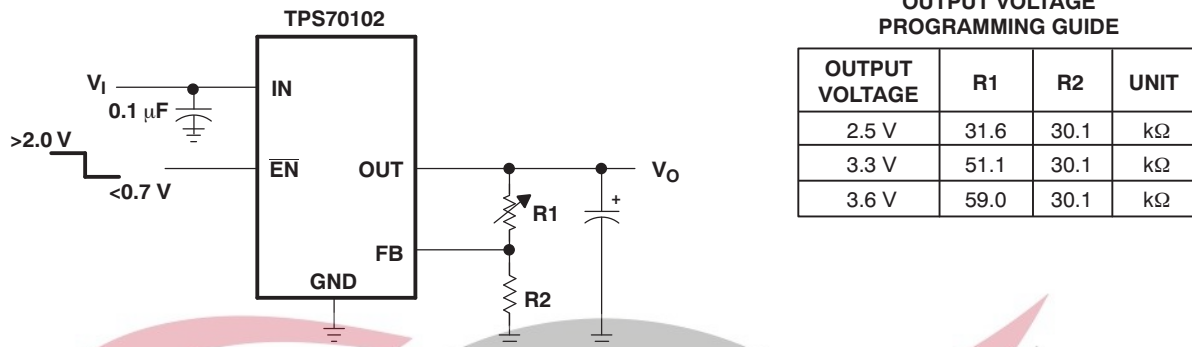

Figure 50. TPS70102 Adjustable LDO Regulator Programming

### Regulator Protection

Both TPS701xx PMOS-pass transistors have built-in back diodes that conduct reverse currents when the input voltage drops below the output voltage (for example, during power-down). Current is conducted from the output to the input and is not internally limited. When extended reverse voltage is anticipated, external limiting may be appropriate.

The TPS701xx also features internal current limiting and thermal protection. During normal operation, the TPS701xx regulator 1 limits output current to approximately 1.6A (typ) and regulator 2 limits output current to approximately 750mA (typ). When current limiting engages, the output voltage scales back linearly until the overcurrent condition ends. While current limiting is designed to prevent gross device failure, care should be taken not to exceed the power dissipation ratings of the package. If the temperature of the device exceeds +150°C (typ), thermal-protection circuitry shuts it down. Once the device has cooled below +130°C (typ), regulator operation resumes.

### Power Dissipation and Junction Temperature

Specified regulator operation is assured to a junction temperature of +125°C; the maximum junction temperature should be restricted to +125°C under normal operating conditions. This restriction limits the power dissipation the regulator can handle in any given application. To ensure the junction temperature is within acceptable limits, calculate the maximum allowable dissipation,  $P_{D(max)}$ , and the actual dissipation,  $P_D$ , which must be less than or equal to  $P_{D(max)}$ .

The maximum-power-dissipation limit is determined using [Equation 2](#):

$$P_{D(max)} = \frac{T_{Jmax} - T_A}{R_{\theta JA}} \quad (2)$$

where:

- $T_{Jmax}$  is the maximum allowable junction temperature
- $R_{\theta JA}$  is the thermal resistance junction-to-ambient for the package; that is, 32.6°C/W for the 20-terminal PWP with no airflow
- $T_A$  is the ambient temperature

The regulator dissipation is calculated using [Equation 3](#):

$$P_D = (V_I - V_O) \times I_O \quad (3)$$

Power dissipation resulting from quiescent current is negligible. Excessive power dissipation will trigger the thermal protection circuit.

## REVISION HISTORY

NOTE: Page numbers for previous revisions may differ from page numbers in the current version.

### Changes from Revision H (December, 2009) to Revision I Page

- Replaced the *Dissipation Ratings* table with the *Thermal Information* table ..... 4

### Changes from Revision G (August, 2009) to Revision H Page

- Corrected typo in *output current limit* specification units ..... 5
- Corrected typo in  $V_{OUT2}$  *UV comparator*, falling edge deglitch specification units ..... 5



**PACKAGING INFORMATION**

Orderable Device	Status (1)	Package Type	Package Drawing	Pins	Package Qty	Eco Plan (2)	Lead finish/ Ball material (6)	MSL Peak Temp (3)	Op Temp (°C)	Device Marking (4/5)	Samples
TPS70102PWP	ACTIVE	HTSSOP	PWP	20	70	Green (RoHS & no Sb/Br)	NIPDAU	Level-2-260C-1 YEAR	-40 to 125	PT70102	<a href="#">Samples</a>
TPS70102PWPG4	ACTIVE	HTSSOP	PWP	20	70	Green (RoHS & no Sb/Br)	NIPDAU	Level-2-260C-1 YEAR	-40 to 125	PT70102	<a href="#">Samples</a>
TPS70102PWPR	ACTIVE	HTSSOP	PWP	20	2000	Green (RoHS & no Sb/Br)	NIPDAU	Level-2-260C-1 YEAR	-40 to 125	PT70102	<a href="#">Samples</a>
TPS70102PWPRG4	ACTIVE	HTSSOP	PWP	20	2000	Green (RoHS & no Sb/Br)	NIPDAU	Level-2-260C-1 YEAR	-40 to 125	PT70102	<a href="#">Samples</a>
TPS70145PWP	ACTIVE	HTSSOP	PWP	20	70	Green (RoHS & no Sb/Br)	NIPDAU	Level-2-260C-1 YEAR	-40 to 125	PT70145	<a href="#">Samples</a>
TPS70145PWPG4	ACTIVE	HTSSOP	PWP	20	70	Green (RoHS & no Sb/Br)	NIPDAU	Level-2-260C-1 YEAR	-40 to 125	PT70145	<a href="#">Samples</a>
TPS70145PWPR	ACTIVE	HTSSOP	PWP	20	2000	Green (RoHS & no Sb/Br)	NIPDAU	Level-2-260C-1 YEAR	-40 to 125	PT70145	<a href="#">Samples</a>
TPS70145PWPRG4	ACTIVE	HTSSOP	PWP	20	2000	Green (RoHS & no Sb/Br)	NIPDAU	Level-2-260C-1 YEAR	-40 to 125	PT70145	<a href="#">Samples</a>
TPS70148PWP	ACTIVE	HTSSOP	PWP	20	70	Green (RoHS & no Sb/Br)	NIPDAU	Level-2-260C-1 YEAR	-40 to 125	PT70148	<a href="#">Samples</a>
TPS70148PWPG4	ACTIVE	HTSSOP	PWP	20	70	Green (RoHS & no Sb/Br)	NIPDAU	Level-2-260C-1 YEAR	-40 to 125	PT70148	<a href="#">Samples</a>
TPS70148PWPR	ACTIVE	HTSSOP	PWP	20	2000	Green (RoHS & no Sb/Br)	NIPDAU	Level-2-260C-1 YEAR	-40 to 125	PT70148	<a href="#">Samples</a>
TPS70148PWPRG4	ACTIVE	HTSSOP	PWP	20	2000	Green (RoHS & no Sb/Br)	NIPDAU	Level-2-260C-1 YEAR	-40 to 125	PT70148	<a href="#">Samples</a>
TPS70151PWP	ACTIVE	HTSSOP	PWP	20	70	Green (RoHS & no Sb/Br)	NIPDAU	Level-2-260C-1 YEAR	-40 to 125	PT70151	<a href="#">Samples</a>
TPS70151PWPG4	ACTIVE	HTSSOP	PWP	20	70	Green (RoHS & no Sb/Br)	NIPDAU	Level-2-260C-1 YEAR	-40 to 125	PT70151	<a href="#">Samples</a>
TPS70151PWPR	ACTIVE	HTSSOP	PWP	20	2000	Green (RoHS & no Sb/Br)	NIPDAU	Level-2-260C-1 YEAR	-40 to 125	PT70151	<a href="#">Samples</a>
TPS70151PWPRG4	ACTIVE	HTSSOP	PWP	20	2000	Green (RoHS & no Sb/Br)	NIPDAU	Level-2-260C-1 YEAR	-40 to 125	PT70151	<a href="#">Samples</a>

Orderable Device	Status (1)	Package Type	Package Drawing	Pins	Package Qty	Eco Plan (2)	Lead finish/ Ball material (6)	MSL Peak Temp (3)	Op Temp (°C)	Device Marking (4/5)	Samples
TPS70158PWP	ACTIVE	HTSSOP	PWP	20	70	Green (RoHS & no Sb/Br)	NIPDAU	Level-2-260C-1 YEAR	-40 to 125	PT70158	<a href="#">Samples</a>
TPS70158PWPG4	ACTIVE	HTSSOP	PWP	20	70	Green (RoHS & no Sb/Br)	NIPDAU	Level-2-260C-1 YEAR	-40 to 125	PT70158	<a href="#">Samples</a>
TPS70158PWPR	ACTIVE	HTSSOP	PWP	20	2000	Green (RoHS & no Sb/Br)	NIPDAU	Level-2-260C-1 YEAR	-40 to 125	PT70158	<a href="#">Samples</a>

(1) The marketing status values are defined as follows:

**ACTIVE:** Product device recommended for new designs.

**LIFEBUY:** TI has announced that the device will be discontinued, and a lifetime-buy period is in effect.

**NRND:** Not recommended for new designs. Device is in production to support existing customers, but TI does not recommend using this part in a new design.

**PREVIEW:** Device has been announced but is not in production. Samples may or may not be available.

**OBSOLETE:** TI has discontinued the production of the device.

(2) **RoHS:** TI defines "RoHS" to mean semiconductor products that are compliant with the current EU RoHS requirements for all 10 RoHS substances, including the requirement that RoHS substance do not exceed 0.1% by weight in homogeneous materials. Where designed to be soldered at high temperatures, "RoHS" products are suitable for use in specified lead-free processes. TI may reference these types of products as "Pb-Free".

**RoHS Exempt:** TI defines "RoHS Exempt" to mean products that contain lead but are compliant with EU RoHS pursuant to a specific EU RoHS exemption.

**Green:** TI defines "Green" to mean the content of Chlorine (Cl) and Bromine (Br) based flame retardants meet JS709B low halogen requirements of <=1000ppm threshold. Antimony trioxide based flame retardants must also meet the <=1000ppm threshold requirement.

(3) MSL, Peak Temp. - The Moisture Sensitivity Level rating according to the JEDEC industry standard classifications, and peak solder temperature.

(4) There may be additional marking, which relates to the logo, the lot trace code information, or the environmental category on the device.

(5) Multiple Device Markings will be inside parentheses. Only one Device Marking contained in parentheses and separated by a "~" will appear on a device. If a line is indented then it is a continuation of the previous line and the two combined represent the entire Device Marking for that device.

(6) Lead finish/Ball material - Orderable Devices may have multiple material finish options. Finish options are separated by a vertical ruled line. Lead finish/Ball material values may wrap to two lines if the finish value exceeds the maximum column width.

**Important Information and Disclaimer:** The information provided on this page represents TI's knowledge and belief as of the date that it is provided. TI bases its knowledge and belief on information provided by third parties, and makes no representation or warranty as to the accuracy of such information. Efforts are underway to better integrate information from third parties. TI has taken and continues to take reasonable steps to provide representative and accurate information but may not have conducted destructive testing or chemical analysis on incoming materials and chemicals. TI and TI suppliers consider certain information to be proprietary, and thus CAS numbers and other limited information may not be available for release.

In no event shall TI's liability arising out of such information exceed the total purchase price of the TI part(s) at issue in this document sold by TI to Customer on an annual basis.



**TAPE AND REEL INFORMATION**

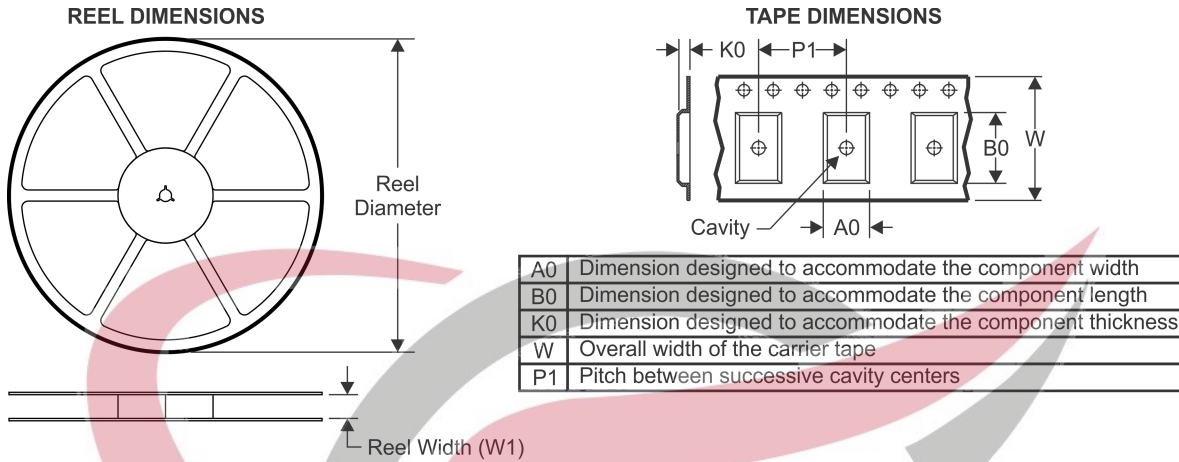

**QUADRANT ASSIGNMENTS FOR PIN 1 ORIENTATION IN TAPE**

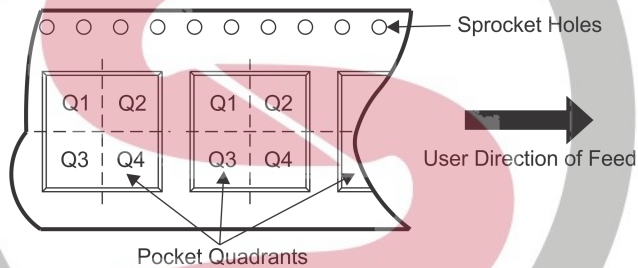

\*All dimensions are nominal

Device	Package Type	Package Drawing	Pins	SPQ	Reel Diameter (mm)	Reel Width W1 (mm)	A0 (mm)	B0 (mm)	K0 (mm)	P1 (mm)	W (mm)	Pin1 Quadrant
TPS70102PWPR	HTSSOP	PWP	20	2000	330.0	16.4	6.95	7.1	1.6	8.0	16.0	Q1
TPS70145PWPR	HTSSOP	PWP	20	2000	330.0	16.4	6.95	7.1	1.6	8.0	16.0	Q1
TPS70148PWPR	HTSSOP	PWP	20	2000	330.0	16.4	6.95	7.1	1.6	8.0	16.0	Q1
TPS70151PWPR	HTSSOP	PWP	20	2000	330.0	16.4	6.95	7.1	1.6	8.0	16.0	Q1
TPS70158PWPR	HTSSOP	PWP	20	2000	330.0	16.4	6.95	7.1	1.6	8.0	16.0	Q1

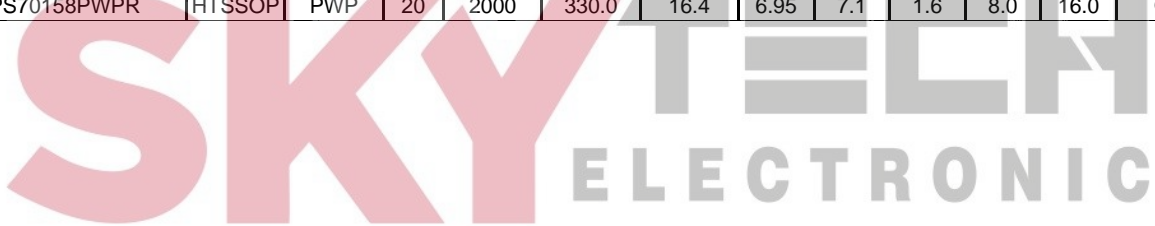

TAPE AND REEL BOX DIMENSIONS

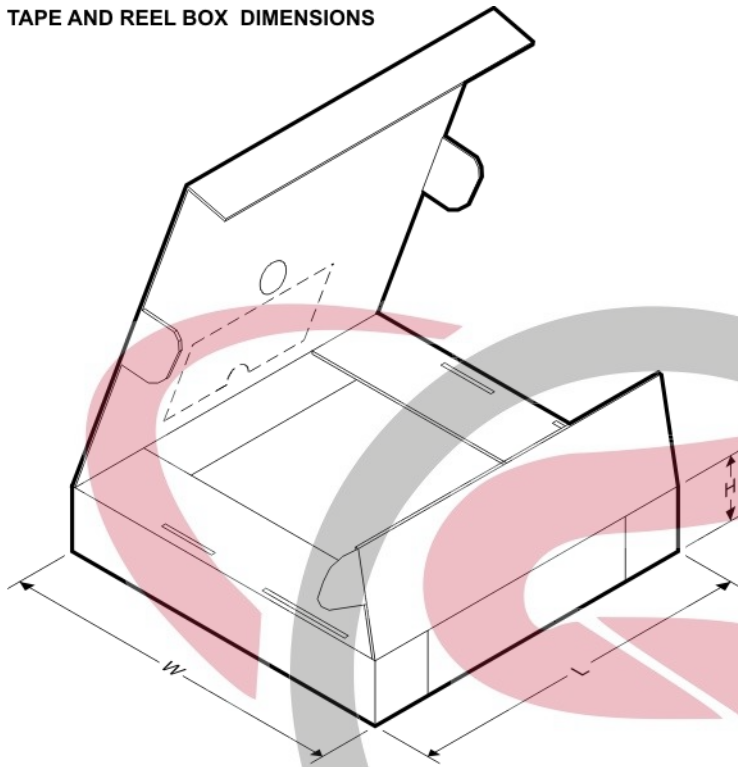

\*All dimensions are nominal

Device	Package Type	Package Drawing	Pins	SPQ	Length (mm)	Width (mm)	Height (mm)
TPS70102PWPR	HTSSOP	PWP	20	2000	350.0	350.0	43.0
TPS70145PWPR	HTSSOP	PWP	20	2000	350.0	350.0	43.0
TPS70148PWPR	HTSSOP	PWP	20	2000	350.0	350.0	43.0
TPS70151PWPR	HTSSOP	PWP	20	2000	350.0	350.0	43.0
TPS70158PWPR	HTSSOP	PWP	20	2000	350.0	350.0	43.0

**SKY**TECH  
ELECTRONIC

PWP (R-PDSO-G20)

PowerPAD™ PLASTIC SMALL OUTLINE

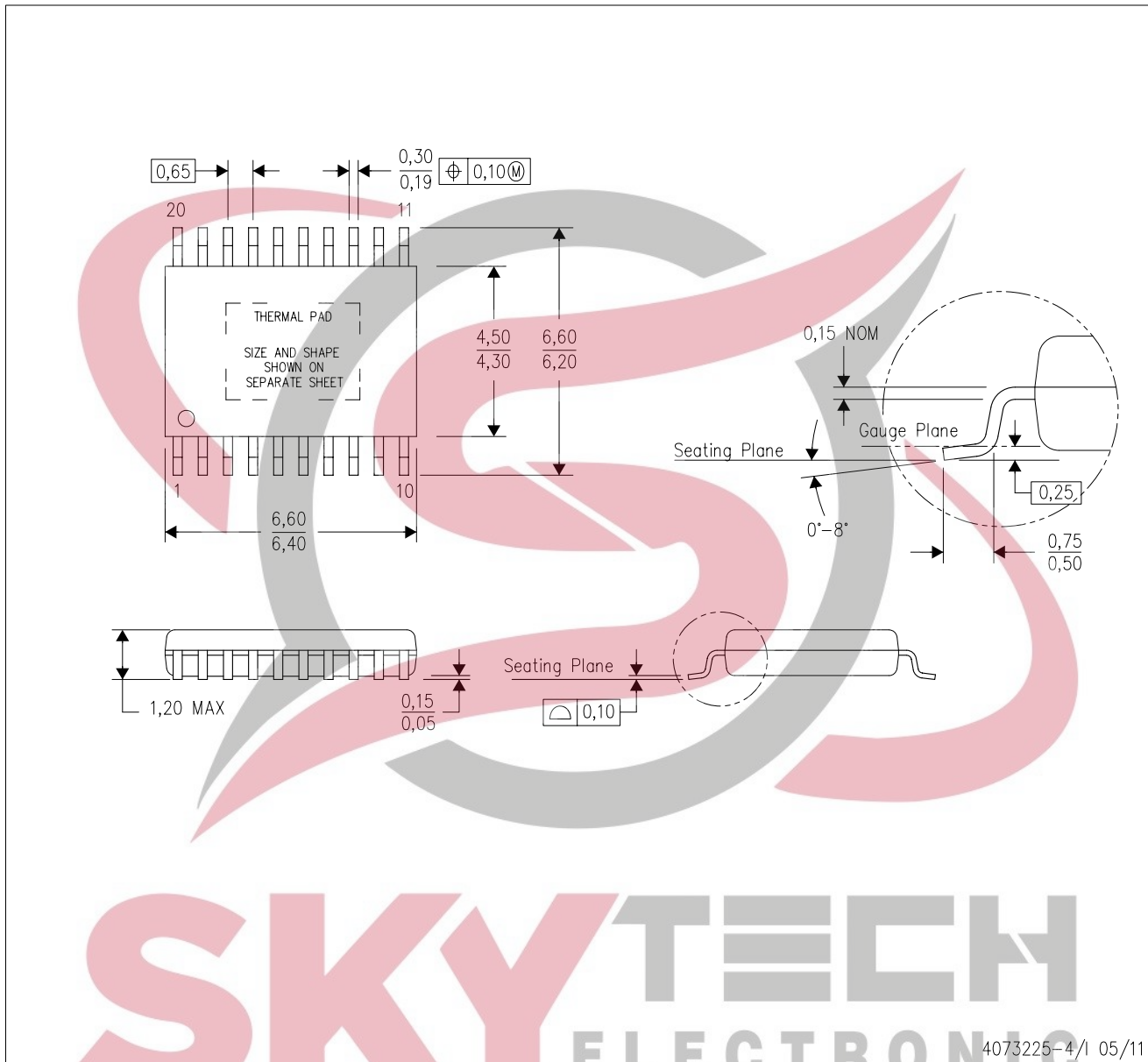

4073225-4/1 05/11

- NOTES:
- A. All linear dimensions are in millimeters.
  - B. This drawing is subject to change without notice.
  - C. Body dimensions do not include mold flash or protrusions. Mold flash and protrusion shall not exceed 0.15 per side.
  - D. This package is designed to be soldered to a thermal pad on the board. Refer to Technical Brief, PowerPad Thermally Enhanced Package, Texas Instruments Literature No. SLMA002 for information regarding recommended board layout. This document is available at [www.ti.com](http://www.ti.com) <<http://www.ti.com>>.
  - E. See the additional figure in the Product Data Sheet for details regarding the exposed thermal pad features and dimensions.
  - E. Falls within JEDEC MO-153

PowerPAD is a trademark of Texas Instruments.



# THERMAL PAD MECHANICAL DATA

## PWP (R-PDSO-G20) PowerPAD™ SMALL PLASTIC OUTLINE

### THERMAL INFORMATION

This PowerPAD™ package incorporates an exposed thermal pad that is designed to be attached to a printed circuit board (PCB). The thermal pad must be soldered directly to the PCB. After soldering, the PCB can be used as a heatsink. In addition, through the use of thermal vias, the thermal pad can be attached directly to the appropriate copper plane shown in the electrical schematic for the device, or alternatively, can be attached to a special heatsink structure designed into the PCB. This design optimizes the heat transfer from the integrated circuit (IC).

For additional information on the PowerPAD package and how to take advantage of its heat dissipating abilities, refer to Technical Brief, PowerPAD Thermally Enhanced Package, Texas Instruments Literature No. SLMA002 and Application Brief, PowerPAD Made Easy, Texas Instruments Literature No. SLMA004. Both documents are available at [www.ti.com](http://www.ti.com).

The exposed thermal pad dimensions for this package are shown in the following illustration.

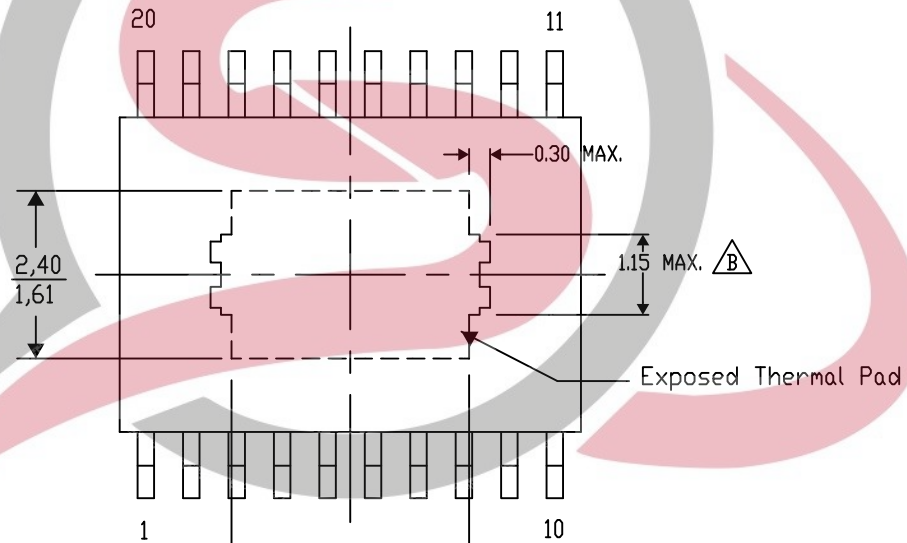

4206332-15/AO 01/16

NOTE: A. All linear dimensions are in millimeters

 Exposed tie strap features may not be present.

PowerPAD is a trademark of Texas Instruments

PWP (R-PDSO-G20)

PowerPAD™ PLASTIC SMALL OUTLINE

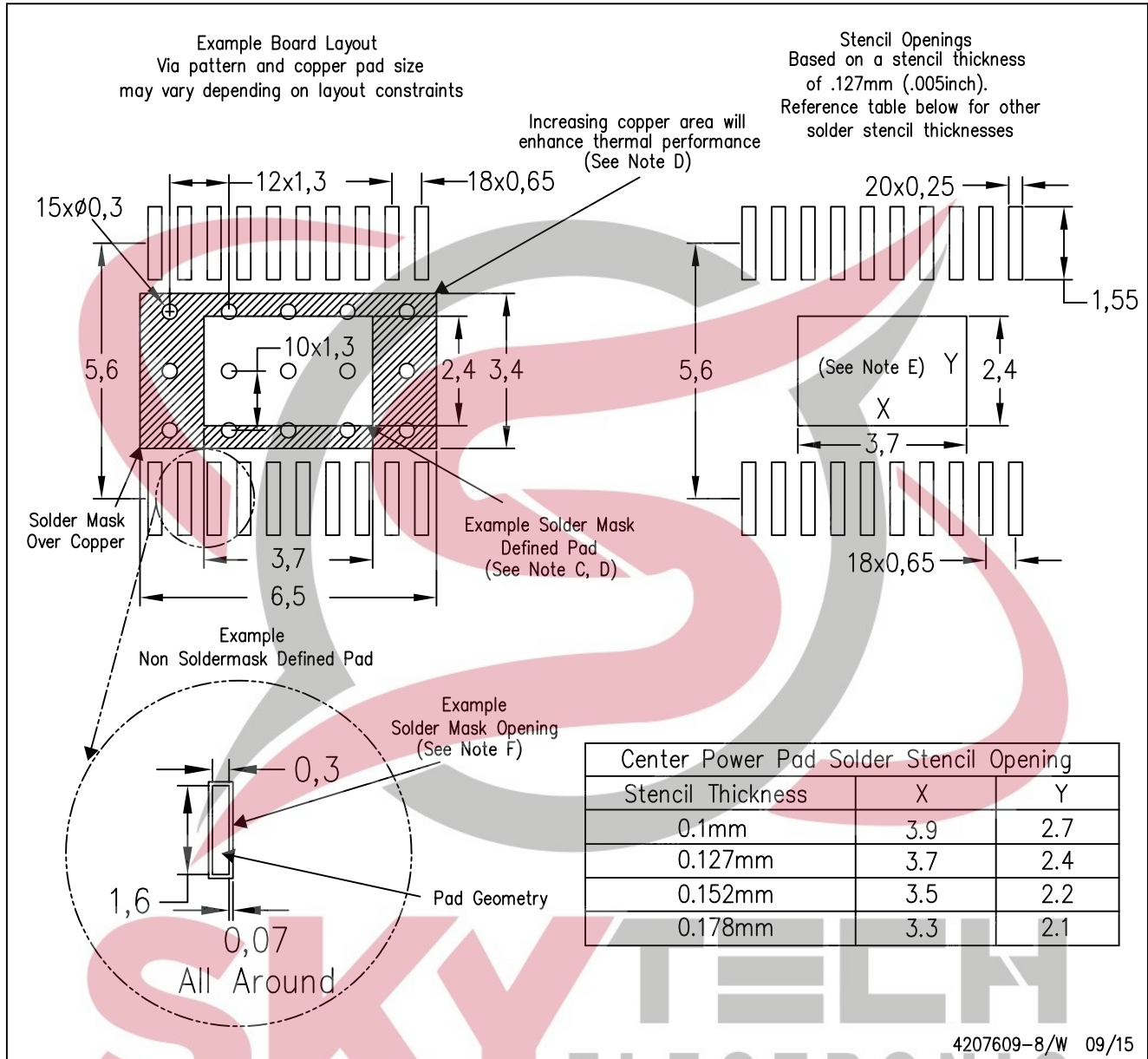

- NOTES:
- All linear dimensions are in millimeters.
  - This drawing is subject to change without notice.
  - Customers should place a note on the circuit board fabrication drawing not to alter the center solder mask defined pad.
  - This package is designed to be soldered to a thermal pad on the board. Refer to Technical Brief, PowerPad Thermally Enhanced Package, Texas Instruments Literature No. SLMA002, SLMA004, and also the Product Data Sheets for specific thermal information, via requirements, and recommended board layout. These documents are available at [www.ti.com](http://www.ti.com) <<http://www.ti.com>>. Publication IPC-7351 is recommended for alternate designs.
  - Laser cutting apertures with trapezoidal walls and also rounding corners will offer better paste release. Customers should contact their board assembly site for stencil design recommendations. Example stencil design based on a 50% volumetric metal load solder paste. Refer to IPC-7525 for other stencil recommendations.
  - Customers should contact their board fabrication site for solder mask tolerances between and around signal pads.

## IMPORTANT NOTICE AND DISCLAIMER

TI PROVIDES TECHNICAL AND RELIABILITY DATA (INCLUDING DATASHEETS), DESIGN RESOURCES (INCLUDING REFERENCE DESIGNS), APPLICATION OR OTHER DESIGN ADVICE, WEB TOOLS, SAFETY INFORMATION, AND OTHER RESOURCES "AS IS" AND WITH ALL FAULTS, AND DISCLAIMS ALL WARRANTIES, EXPRESS AND IMPLIED, INCLUDING WITHOUT LIMITATION ANY IMPLIED WARRANTIES OF MERCHANTABILITY, FITNESS FOR A PARTICULAR PURPOSE OR NON-INFRINGEMENT OF THIRD PARTY INTELLECTUAL PROPERTY RIGHTS.

These resources are intended for skilled developers designing with TI products. You are solely responsible for (1) selecting the appropriate TI products for your application, (2) designing, validating and testing your application, and (3) ensuring your application meets applicable standards, and any other safety, security, or other requirements. These resources are subject to change without notice. TI grants you permission to use these resources only for development of an application that uses the TI products described in the resource. Other reproduction and display of these resources is prohibited. No license is granted to any other TI intellectual property right or to any third party intellectual property right. TI disclaims responsibility for, and you will fully indemnify TI and its representatives against, any claims, damages, costs, losses, and liabilities arising out of your use of these resources.

TI's products are provided subject to TI's Terms of Sale ([www.ti.com/legal/termsofsale.html](http://www.ti.com/legal/termsofsale.html)) or other applicable terms available either on [ti.com](http://ti.com) or provided in conjunction with such TI products. TI's provision of these resources does not expand or otherwise alter TI's applicable warranties or warranty disclaimers for TI products.

Mailing Address: Texas Instruments, Post Office Box 655303, Dallas, Texas 75265  
Copyright © 2020, Texas Instruments Incorporated



**SKY**TECH  
ELECTRONIC